

SHARP®

MODEL

AR-M208

DIGITAL MULTIFUNCTIONAL SYSTEM

OPERATION MANUAL

	Page
• GETTING STARTED	5
• MAKING COPIES	23
• SPECIAL FUNCTIONS	47
• COPIER TROUBLE?	71
• GENERAL INFORMATION ...	85
• OPTIONAL EQUIPMENT	99

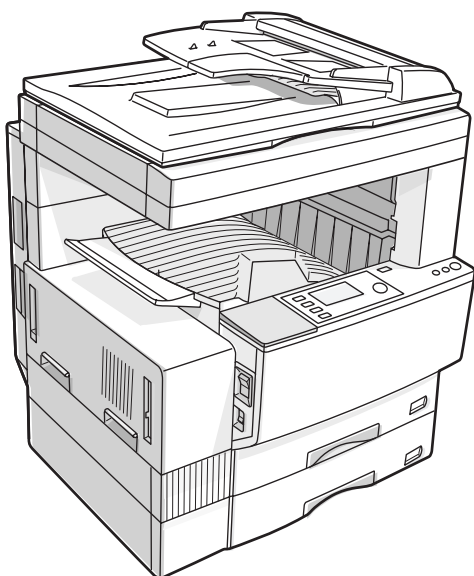

FOR YOUR RECORDS ...

To protect against loss or theft, record and retain for reference the copier's serial number located on the back of the unit.

Model Number _____

Serial Number _____

Date of Purchase _____

Place of Purchase _____

Authorized Sharp Copier

Service Department Number _____

OUTLINE OF THIS MANUAL

1. GETTING STARTED

This chapter describes the basic information on the use of this copier.

1

2. MAKING COPIES

This chapter describes the basic copying functions such as normal copying, reduction or enlargement, and exposure adjustments.

2

3. SPECIAL FUNCTIONS

This chapter describes special copying functions including various image editing functions.

3

4. COPIER TROUBLE?

This chapter describes how to remove misfed paper and how to remedy minor problems.

4

5. GENERAL INFORMATION

This chapter describes general information about the use of the copier and the loading of paper and toner.

5

6. OPTIONAL EQUIPMENT

This chapter describes operating instructions for the Single Pass Feeder (AR-SP4), the Reversing Single Pass Feeder (AR-RP3), the Finisher (AR-FN5 N), the 500-Sheet Paper Feed Unit (AR-D11), and the 2 x 500-Sheet Paper Feed Unit (AR-D12).

6

CONTENTS

Page

CHAPTER 1 GETTING STARTED

INTRODUCTION	6
CAUTIONS	7
COPIER INSTALLATION	8
MAIN FEATURES	10
PART NAMES AND FUNCTIONS	12
● Exterior	12
● Interior	13
● Operation panel	14
POWER ON AND OFF	16
● Power on	16
● Power off	16
● Dehumidification heater switch (DH POWER)	16
● Initial settings	17
● Power save modes	17
FUNCTION ICONS	18
FUNCTION REVIEW	19
AUDITING ACCOUNTS	20
● How to copy in the auditing mode	20

CHAPTER 2 MAKING COPIES

COPYING FROM THE PLATEN GLASS	24
COPYING FROM THE RSPF	26
● About reversing single pass feeder (RSPF)	26
● Using the RSPF	26
TWO-SIDED COPYING	28
● Two-sided copies from one-sided originals	28
● Two-sided copies from two-sided originals	28
● One-sided copies from two-sided originals	28
EXPOSURE ADJUSTMENT	34
REDUCTION/ENLARGEMENT/ZOOM	36
● Automatic selection	36
● Manual selection	38
ROTATION COPYING	40
BYPASS FEED (special paper)	41
● Acceptable paper for copying from the bypass tray	41
● Copying from the bypass tray	41
INTERRUPTING A COPY RUN	44

CHAPTER 3 SPECIAL FUNCTIONS

SORT/GROUP	48
● Copying in the sort or group mode	48
MARGIN SHIFT	51
ERASE	53
DUAL PAGE COPY	55
2 IN 1 OR 4 IN 1	57
B/W REVERSE	60
XY ZOOM	62
TRANSPARENCY	65
JOB MEMORY	67
● Storing a job program	67
● Deleting a job program	68
● Recalling a job program	69

	Page
CHAPTER 4 COPIER TROUBLE?	
STATUS MESSAGES	72
MISFEED REMOVAL	73
● Misfeed in the RSPF	73
● Misfeed in the bypass tray	75
● Misfeed in the copier	76
● Misfeed in the center tray	79
● Misfeed in the upper paper tray	80
● Misfeed in the lower paper tray	80
● Misfeed in the upper exit area	81
TROUBLESHOOTING	83
CHAPTER 5 GENERAL INFORMATION	
PAPER	86
● Types and sizes of copy paper	86
● Loading copy paper	86
● Changing the copy paper size in the tray	88
TONER CARTRIDGE REPLACEMENT	90
CHECKING THE TONER QUANTITY AND TOTAL OUTPUT COUNT	92
CLEANING THE PLATEN GLASS AND RSPF	93
CLEANING THE BYPASS TRAY PAPER FEED ROLLER	94
DISPLAY CONTRAST ADJUSTMENT	95
STORAGE OF SUPPLIES	96
● Proper storage	96
SPECIFICATIONS	97
CHAPTER 6 OPTIONAL EQUIPMENT	
SYSTEM CONFIGURATION	100
FINISHER (AR-FN5 N)	101
● Part names	101
● Specifications	102
● Supplies	102
● Finisher functions	103
● Staple sort	104
● Staple cartridge replacement	107
● Staple jam removal	108
● Misfeed removal	110
500-SHEET PAPER FEED UNIT (AR-D11)/ 2x500-SHEET PAPER FEED UNIT (AR-D12)	112
● Part names	112
● Specifications	112
● Loading copy paper	113
● Changing the copy paper size in the tray	113
● Misfeed removal	113
INDEX	115

CHAPTER 1

GETTING STARTED

This chapter describes the basic information on the use of this copier.

	Page
● INTRODUCTION	6
● CAUTIONS	7
● COPIER INSTALLATION	8
● MAIN FEATURES	10
● PART NAMES AND FUNCTIONS	12
Exterior	12
Interior	13
Operation panel	14
● POWER ON AND OFF	16
Power on	16
Power off	16
Dehumidification heater switch (DH POWER)	16
Initial settings	17
Power save modes	17
● FUNCTION ICONS	18
● FUNCTION REVIEW	19
● AUDITING ACCOUNTS	20
How to copy in the auditing mode	20

INTRODUCTION

This copier has been designed to provide convenient copying features in a minimum amount of office space and with maximum operational ease. To get full use of all copier features, be sure to familiarize yourself with this manual and the copier. For quick reference during copier use, keep this manual in a handy location.

About the operation manuals

The operation manuals for the unit are as follows:

Operation Manual (Digital Multifunctional System)

This manual contains explanations of the product and procedures for using the unit as a copier.

Operation Manual (Multi Access)

This manual explains the procedures for using a function while another function is in use.

NOTES:

- This copier can be used as a network laser printer. This copier can also be used as a facsimile machine and a scanner by installing optional components. However, this manual describes only the copier features. For description of the other features, see the separate relevant manuals.
- All descriptions in this manual are based on the assumption that the COPY mode has been selected (the COPY indicator is on).
- A separate KEY OPERATOR'S GUIDE is written especially for key operators. It contains the programs and programming information that will enable the key operators to tailor functions for maximum benefit.
- The operation procedures and the display on the operation panel vary with installation of optional devices. The descriptions and the illustrations in this manual are mainly for the copier without any option installed.
- No part of these manuals may be reproduced in any form without permission from Sharp Corporation.
- We reserve the right to change the contents of these manuals without notice for purposes of improvement.
- Microsoft, Windows, and Windows NT are trademarks of Microsoft Corporation in the U.S.A. and other countries.
- IBM and PC/AT are trademarks of International Business Machines Corporation.
- Adobe, and Acrobat are trademarks of Adobe Systems Incorporated.
- All other trademarks and copyrights are the property of their respective owners.

Conventions used in this manual



WARNING:

Warns the user that injury to the user or damage to the copier may result if the contents of the warning are not properly followed.



CAUTION:

Cautions the user that damage to the copier or one of its components may result if the contents of the caution are not properly followed.

NOTE:

Notes provide information relevant to the copier regarding specifications, functions, performance, operation and such, that may be useful to the user.

★KEY OPERATOR

Information which is relevant to key operator functions is described. The key operator must pay close attention to these notes.

CAUTIONS

Follow the cautions below when using this copier.



WARNING:

- The fusing area is hot. Exercise care in this area when removing misfed paper.
- Do not look directly at the light source. Doing so may damage your eyes.



CAUTION:

- The socket-outlet should be installed near the equipment and shall be easily accessible.
- Place the copier on a firm, level surface.
- Do not install the copier in a humid or dusty location.
- When the copier is not used for a long time, for example, during prolonged holidays, turn the power switch off and remove the power cord from the outlet.
- When moving the copier, be sure to turn the power switch off and remove the power cord from the outlet.
- Do not cover the copier with a dust cover, cloth or plastic film while the power is on. Doing so may prevent heat dissipation, damaging the copier.
- Do not drop the copier, subject it to shock or strike it against any object.
- Store spare toner cartridges in a cool dry place without removing from the package before use. If they are exposed to direct sunlight or excessive heat, poor copies may result.
- Do not touch the photoconductive drum (green portion). Scratches or smudges on the drum will cause dirty copies.
- Use of controls or adjustments or performance of procedures other than those specified herein may result in hazardous laser radiation exposure.

SAFETY PRECAUTIONS

- This Digital Copier is rated Class 1 and complies with 21 CFR 1040.10 and 1040.11 of the CDRH standards. This means that the copier does not produce hazardous laser radiation. For your safety, observe the precautions below.
- Do not remove the cabinet, operation panel or any other covers.
- The copier's exterior covers contain several safety interlock switches. Do not bypass any safety interlock by inserting wedges or other items into switch slots.

"BATTERY DISPOSAL"

THIS MACHINE CONTAINS MANGANESE DIOXIDE BATTERY WHICH MUST BE DISPOSED OF PROPERLY. CONTACT YOUR SHARP DEALER OR SERVICER FOR INSTRUCTIONS.

This product utilizes tin-lead solder, and a fluorescent lamp containing a small amount of mercury. Disposal of these materials may be regulated due to environmental considerations. For disposal or recycling information, please contact your local authorities or the Electronics Industries Alliance: www.eia.org

COPIER INSTALLATION

Improper installation may damage the copier. Please note the following during initial installation and whenever the copier is moved.



CAUTION:

If the copier is moved from a cool place to a warm place, condensation may form inside the copier. Operation in this condition will cause poor copy quality and malfunctions. Leave the copier at room temperature for at least 2 hours before use.

Do not install your copier in areas that are:

- damp, humid, or very dusty

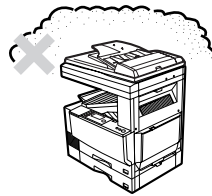

- exposed to direct sunlight

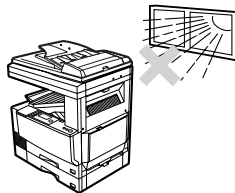

- poorly ventilated

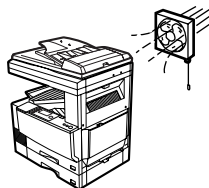

- subject to extreme temperature or humidity changes, e.g., near an air conditioner or heater.

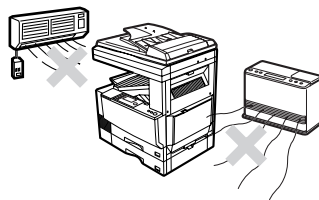

The copier should be installed near an accessible power outlet for easy connection and disconnection.

Be sure to connect the power cord only to a power outlet that meets the specified voltage and current requirements (See page 97.). Also make certain the outlet is properly grounded.

NOTE:

Connect the copier to a power outlet which is not used for other electric appliances. If a lighting fixture is connected to the same outlet, the light may flicker.

Be sure to allow the required space around the machine for servicing and proper ventilation.

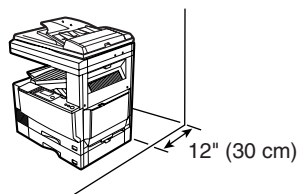

A small amount of ozone is produced within the copier during operation. The emission level is insufficient to cause any health hazard.

NOTE:

The present recommended long term exposure limit for ozone is 0.1 ppm (0.2 mg/m³) calculated as an 8 hr. time-weighted average concentration. However, since the small amount that is emitted may have an objectionable odor, it is advisable to place the copier in a ventilated area.

MAIN FEATURES

1 High-speed laser copying

- First-copy time at 600 dpi is only 4.8 seconds (except when recovering from a power save mode or immediately after power on).
- Copying speed is 20 copies/min. at 600 dpi, which lends itself for business use, providing improvement in working efficiency.

2 High-quality digital image

- High-quality copying at 600 dpi is performed.
- In addition to the automatic exposure mode, the text, text/photo, and photo exposure modes can be adjusted in five steps.
- The photo mode copying function allow clear copying of delicate halftone original images such as monochrome photos and color photos. These modes are adjustable in five steps.

3 Substantial copying features

- Zoom copies can be made from 25% to 400% in 1% increments at 600 dpi. (When the RSPF is being used, the zoom copy ratio range is 50% to 200%.)
- Up to 999 copies can be made in a single run.
- Automatic two-sided copying can be performed. Paper sizes that can be used are 11" x 17", 8-1/2 x 14", 8-1/2 x 13", 8-1/2 x 11", 8-1/2" x 11"R, A4, and A3.
- Multiple sets of copies can be sorted without the aid of a sorter and each set can be offset from the previous set.
- Useful special features such as erase, margin shift, 2 in 1 and 4 in 1, XY zoom, black and white reverse, and dual page copy are available.

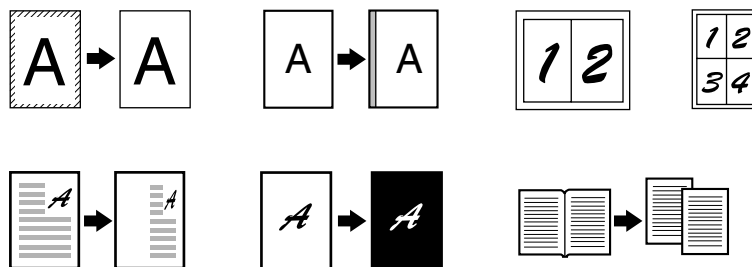

- Key operator programs allow the setting or modification of functions to meet your specific needs. Also the key operator programs allow the internal auditor to be controlled.

4 Scan once/ Print many

- The copier is equipped with a memory buffer allowing the copier to scan an original once and make up to 999 copies of the scanned image. This improves workflow, reduces operating noise from the copier and reduces wear and tear on the scanning mechanism, which provides for a higher reliability.

5 Printer features

- This copier can be used as a network laser printer.

6 Optional features

- A reversing single pass feeder (RSPF) allows automatic document feeding of up to 40 two-sided originals.
- An optional finisher allows automatic stapling of up to 30 sheets.
- This copier can be used as a facsimile machine if an optional facsimile expansion kit is installed.
- This copier can be used as a network scanner if an optional network scanner expansion kit is installed.

7 Environmentally friendly design

- Center tray is housed in the copier for saving space.
- Preheat and auto power shut-off modes are provided to reduce power consumption when the machine is not in active use, and meet the ENERGY STAR guidelines.



PART NAMES AND FUNCTIONS

Exterior

GETTING STARTED

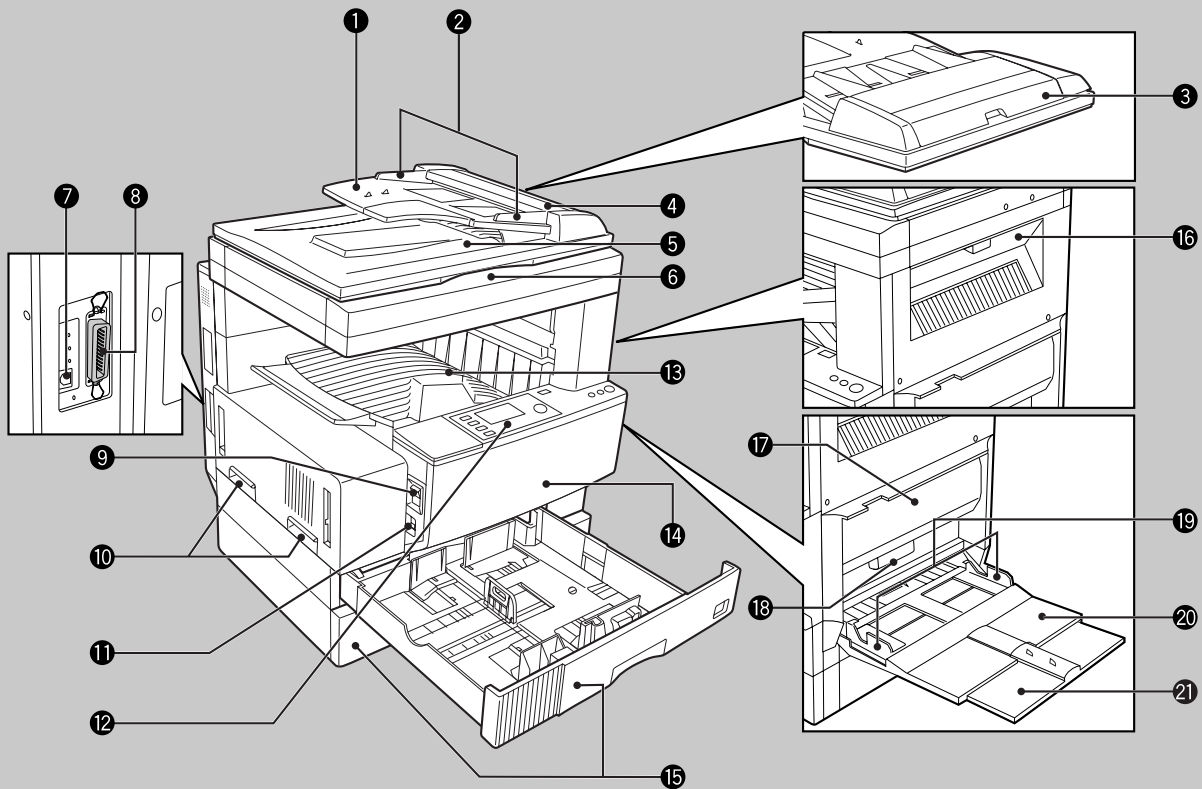

- 1 Document feeder tray (p. 26)**
Hold up to 40 originals.
- 2 Original guides**
Adjust to the size of the originals.
- 3 Right side cover (p. 74)**
Open to remove misfed originals.
- 4 Feeding roller cover (p. 73)**
Open to remove misfed originals.
- 5 Exit area**
Finished originals are output here.
- 6 Platen glass (p. 24)**
Place an original to be copied here.
- 7 USB interface connector**
Plug a USB interface cable into this connector.
- 8 Parallel interface connector**
Plug a parallel interface cable (IEEE 1284) into this connector.
- 9 Power switch (p. 16)**
Press to turn copier power on and off.
- 10 Handles**
Use to move the copier.
- 11 Dehumidification heater switch (p. 16)**
Press to turn on the heater to prevent dew condensation inside the copier and moisture absorption of paper.
- 12 Operation panel (p. 14)**
All copier controls are located here for easy operation.
- 13 Center tray**
Finished copies are deposited in the center tray.
- 14 Front cover (p. 76)**
Open to remove misfeeds and for copier servicing.
- 15 Paper trays (p. 86)**
Each tray holds 500 sheets of copy paper.
- 16 Upper exit area cover (p. 81)**
Open to remove misfeeds when an optional job separator tray kit or finisher is installed.
- 17 Side cover (p. 75)**
Open to remove misfeeds.
- 18 Side cover handle (p. 75)**
Pull to open the side cover.

Interior

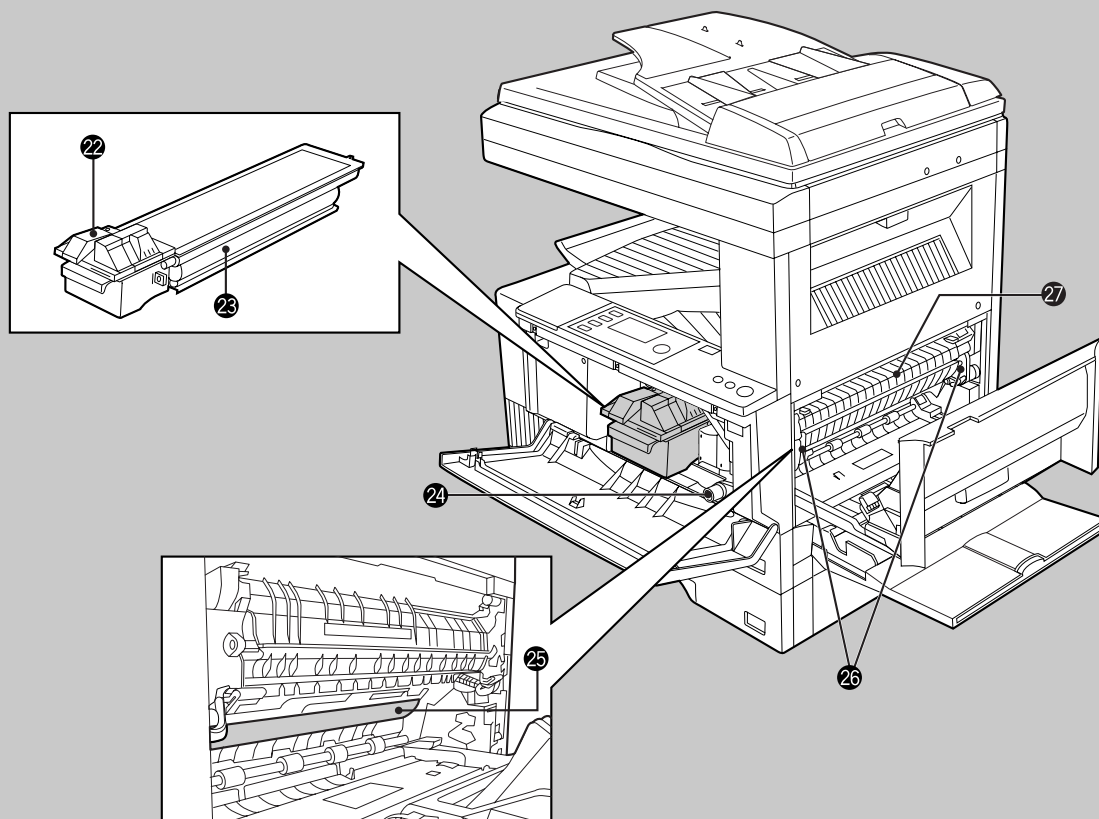

- 19 **Bypass tray paper guides (p. 42)**
Adjust to the width of the copy paper.
- 20 **Bypass tray (p. 41)**
Paper including special paper (such as transparency film) can be fed from the bypass tray.
- 21 **Bypass tray extension (p. 41)**
Pull out when feeding large paper such as 8-1/2" x 11"R, 8-1/2" x 14" and 11" x 17".
- 22 **Toner cartridge lock release lever (p. 90)**
Use to unlock the toner cartridge.
- 23 **Toner cartridge (p. 90)**
Contains toner.
- 24 **Roller rotating knob (p. 77)**
Turn to remove misfed paper.
- 25 **Photoconductive drum**
Copy images are formed on the photoconductive drum.

- 26 **Fusing unit release levers (p. 78)**
Lower to remove misfed paper.
WARNING:
The fusing unit is hot. Take care in removing paper.
- 27 **Paper guide (p. 79)**
Open to remove misfed paper.

Accessories	
Operation manual	1
Key operator's guide	1
Using the printer feature (Printer operation manual)	1
CD-ROM	1
Toner cartridge	1

Operation panel

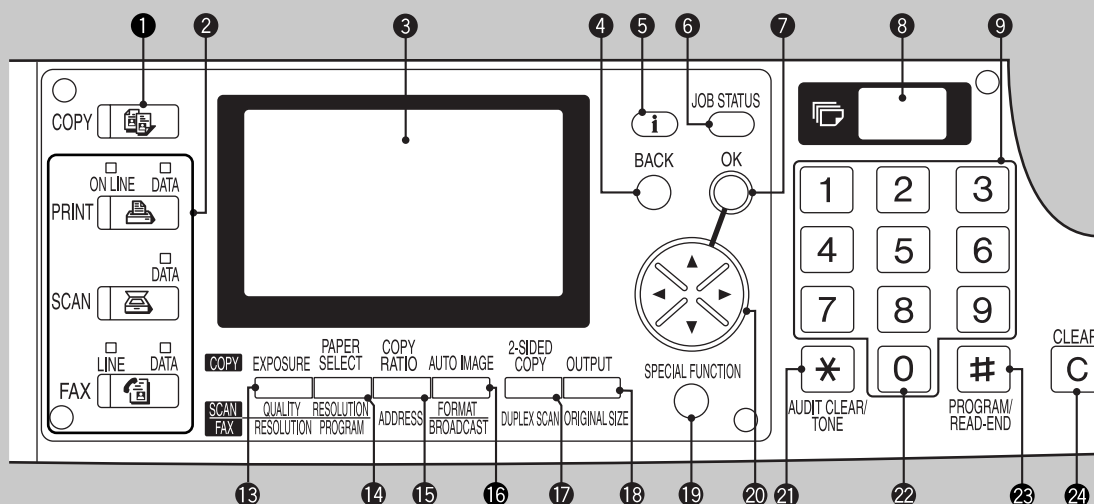

1 COPY key and indicator (p. 84, 92)

Press to select the COPY mode.

Press and hold during standby or during warm-up to display the total output count and the quantity of toner remaining.

2 Mode keys and indicators

Use these keys when relevant optional components are installed.

3 Display

Displays information to assist the operator.

4 BACK key

Press to return the display to the previous screen.

5 Information (i) key (p. 72)

Press to display the detailed description when ① is displayed in the upper right-hand corner of the display.

6 JOB STATUS key (p. 19)

Press to check the settings of selected functions or the status of reserved output jobs.

7 OK key

Press to confirm the selected setting or entered data.

8 Copy quantity display

Displays the specified copy quantity during standby and displays the copy countdown as copies are made.

9 Numeric keys

Use to select the desired copy quantity.

10 INTERRUPT (≡) key and indicator (p. 44)

Interrupts a copy run.

11 CLEAR ALL (CA) key (p. 17)

Clears all selected settings and returns the copier to the initial settings.

12 START (▶) key and indicator

Copying is possible when the indicator is on. Press to start copying.

13 EXPOSURE key (p. 34)

Use to select the exposure modes: AUTO, TEXT, TEXT/PHOTO or PHOTO.

14 PAPER SELECT key (p. 24)

Use to manually select a paper tray.

15 COPY RATIO key (p. 38)

Press to select a reduction or enlargement copy ratio.

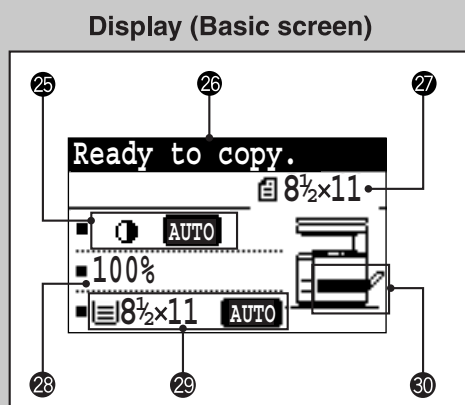
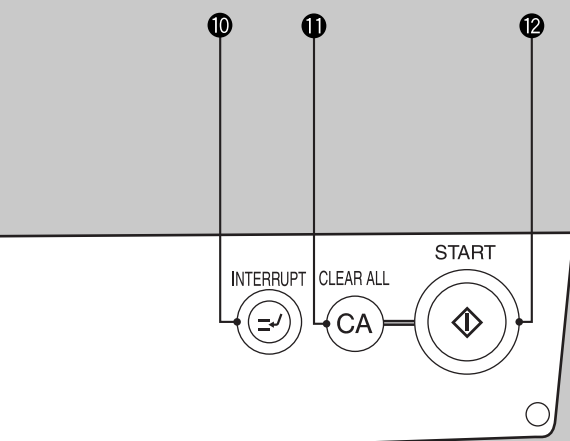
**16 AUTO IMAGE key (p. 37)**

Press for automatic copy ratio selection.

17 2-SIDED COPY key (p. 28)

Press to select the 1-sided to 1-sided, 1-sided to 2-sided, 2-sided to 2-sided or 2-sided to 1-sided copy mode.

18 OUTPUT key (p. 49)

Press to select the sort, group or staple sort* mode.

* To select the staple sort mode, an optional finisher must be installed.

19 SPECIAL FUNCTION key

Press to select special functions.

20 Arrow keys

Press to move the highlighted item in the display.

21 AUDIT CLEAR key (p. 21)

Press to close an open account.

22 Zero key

Use as part of numeric keys to enter copy quantity.

Press during a continuous copy run to display the number of copies completed in the current run.

23 PROGRAM/READ-END key (p. 50, 67)

Press to select the job memory mode.

Press to finish scanning of originals and to start copying when copying in the sort, group or staple sort mode from the platen glass.

24 CLEAR (C) key

Press to clear the copy quantity display or press during a copy run to terminate copying.

25 Exposure display

Indicates the selected exposure mode.

26 Message display

Messages are displayed regarding copier status and operation.

27 Original size display

The original paper size is displayed.

28 Copy ratio display

Displays the copy ratios for reductions or enlargements.

29 Paper size display

Displays the selected paper size. When "AUTO" is displayed, paper size matching the original and copy ratio will be automatically selected.

30 Paper tray display

The selected paper feed location is highlighted.

POWER ON AND OFF

The power switch is located on the left side of the copier.

Power on

Turn the power switch to the "ON" position.

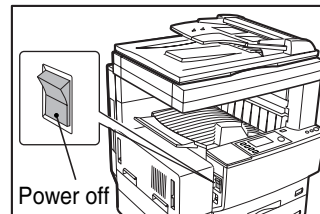
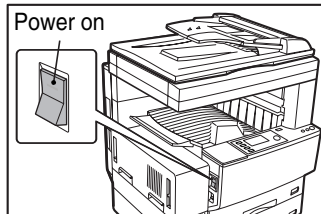

- When the power switch is turned to the "ON" position, the message "System check." will appear in the message display and warm-up will start. During warm-up, you can select your desired job settings and then by pressing the START (⏏) key, your job will commence when the copier comes to "Ready to copy.". Once the copier has finished warming up, the message display will change to "Ready to copy.", and the START (⏏) key indicator will light up, indicating that copying is possible.
- If the copier has been programmed in the auditing mode, the message "Enter your account number." will appear after warming up. Once a valid account number has been entered, the message display will change to "Ready to copy." and copying will be possible. See page 20.

Power off

When the copier is not used for a long time, be sure to turn it off.

Ensure that the machine is not operating and then turn the power switch to the "OFF" position. If the power switch is turned off while the machine is operating, a misfeed may occur. Also the job that was in progress will be totally canceled.

Dehumidification heater switch (DH POWER)

This copier is equipped with a dehumidification heater, which prevents dew condensation inside the copier and moisture absorption of paper in the paper trays. If dew condensation occurs and causes moisture absorption of paper, image quality may be deteriorated and paper misfeeds may occur frequently. It is recommended that the dehumidification heater switch be left in the "ON" position in the following cases even after the power switch is turned off.

- In a low temperature season such as winter (When a sudden temperature change occurs, for example, immediately after room heating is turned on, dew condensation may occur.)
- In a high temperature and high humidity season such as summer or rainy season
- In regions at a high temperature and a high humidity

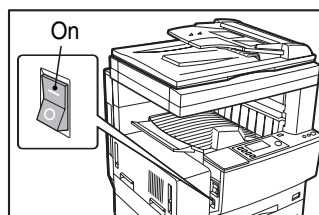

NOTES:

- When using the dehumidification heater, do not remove the power cord from the outlet. Doing so will stop the heater.
- If an optional 500-sheet paper feed unit or 2x500-sheet paper feed unit is installed, the heater in the unit will also be turned on when the dehumidification heater switch of the copier is turned on.

Initial settings

The copier assumes the initial settings when it is first turned on, when the CLEAR ALL (CA) key is pressed, or a preset time (auto clear time) after the last copy is made in any mode. The initial settings that appear in the display are shown below.

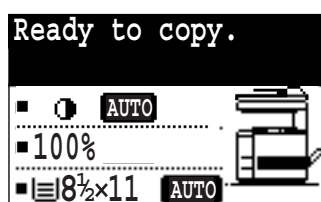

- Copy ratio: 100%
- Exposure: Automatic
- Auto paper selection: On
- Paper feed station: Paper tray 1 (At power on, the previously selected paper tray will again be selected.)
- Copy quantity: 0
- All special copier modes: Off
- ★ **KEY OPERATOR** The auto clear time can be changed. See page 13 of the KEY OPERATOR'S GUIDE.

Power save modes

The copier has two power save modes to reduce overall power consumption and thereby reduce the cost of operation and to conserve natural resources to help reduce environmental pollution. The two power save modes are preheat mode and auto power shut-off mode.

★KEY OPERATOR

The time to enter the preheat and auto power shut-off modes have been preset at the factory to 15 min. for the preheat mode and 30 min. for the auto power shut-off mode. These times can be changed as described in the key operator's guide. It is suggested that you set appropriate times according to the actual usage of the copier.

Preheat mode

The copier will enter the mode once the set time has elapsed without any copier operation after the last copy of a run is made or power is turned on and no copier operations have been made.

When the copier enters the preheat mode, the backlight of the display will be turned off. In this condition, the fuser in the copier is maintained at a lower heat level thereby saving power. The preheat level is, however, high enough to allow the copier to come to a ready condition or begin copying approximately 10 seconds after any key input is made.

To copy from the preheat mode, make desired copier selections and press the START (⏏) key using the normal copying procedure.

★ **KEY OPERATOR** See page 14 of the KEY OPERATOR'S GUIDE for information on setting the preheat mode.

Auto power shut-off mode

If the auto power shut-off mode is enabled, the copier will enter the mode once the set time has elapsed without any copier operation after the last copy of a run is made or the power is first turned on and no copier operations have been made.

When the copier enters the auto power shut-off mode, the displays and all the indicators except the mode indicators (the COPY, PRINT, SCAN, or Fax indicator) will be turned off. In this condition, the fuser in the copier will be turned off.

To turn the power back on, press the COPY key or another mode key that is lit. You can make desired settings and press the START (⏏) key after warm-up starts.

★ **KEY OPERATOR** See page 13 of the KEY OPERATOR'S GUIDE for setting the auto power shut-off timer. See page 16 of the KEY OPERATOR'S GUIDE for enabling or disabling the auto power shut-off.

FUNCTION ICONS

The following function icons will be indicated on the setting screen of each copier function.

2-sided copy mode:



One-sided to two-sided copying



Two-sided to two-sided copying



Two-sided to one-sided copying

Erase:



Edge erase



Center erase



Edge + Center erase

Output mode:



Sort mode



Staple sort mode



Group mode

Dual page copy:



B/W reverse:



Margin shift:



Right



Down



Left

2 in 1 / 4 in 1:



2 in 1



4 in 1

FUNCTION REVIEW

The current settings of copier functions that have been selected can be viewed in the display.

- The XY ZOOM and TRANSPARENCY functions cannot be viewed on the function review screen.

1 Press the JOB STATUS key.

- The review screen will appear.

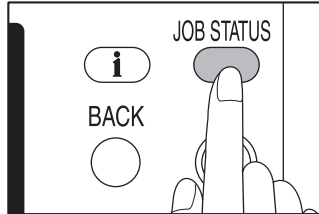

2 Use the ◀ and ▶ keys to select a function.

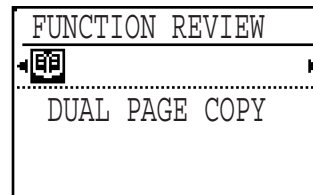
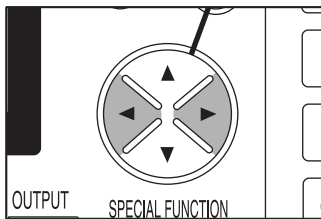

- The setting for the selected function will appear in the display.
- The settings of the 2-sided copy mode (1-sided to 1-sided, etc.), output mode, and special functions can be displayed. Exposure, paper size, and copy ratio settings which are normally displayed on the basic screen cannot be displayed on the review screen.

3 To exit the review screen, press the BACK key.

- The display will return to the basic screen.

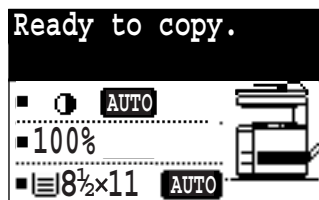

AUDITING ACCOUNTS

If this copier has been programmed in the auditing mode, it will not perform copier functions until an assigned 5-digit account number has been entered.

★ **KEY OPERATOR** See page 17 of the KEY OPERATOR'S GUIDE for setting the auditing mode.

How to copy in the auditing mode

If the copier has been programmed in the auditing mode, the following message will appear in the display in place of the normal initial conditions display.

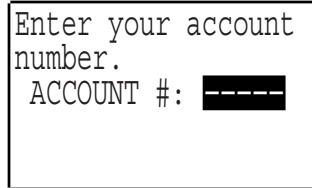

Enter your account number.
ACCOUNT #: -----

1 Enter your account number using the numeric keys.

- As each digit is entered, the dashes in the display will change to asterisks.
- After the number is entered, the following message will appear in the display.

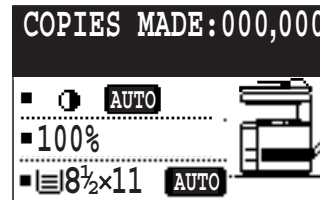
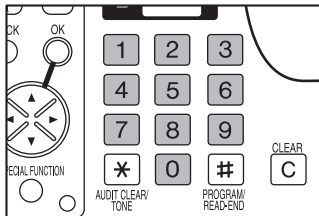

- The message will be displayed for several seconds, then change to the following message.

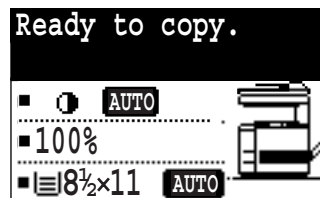

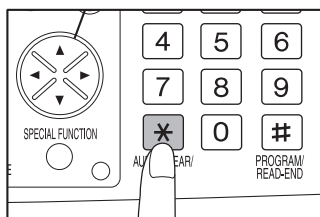
2 When copying is completed, press the **AUDIT CLEAR** key.**NOTE:**

If an unassigned number is entered, "Enter your account number." will appear again in the display, indicating that the number was not accepted.

When the key operator program for account number security has been set and unassigned numbers are entered three successive times, the copier will not accept another number for one minute, and the following message will appear.

⚠ Please see your
key operator for
assistance.

★ **KEY OPERATOR** See page 19 of the **KEY OPERATOR'S GUIDE** for account number security.

CHAPTER 2

MAKING COPIES

This chapter describes the basic copying functions such as normal copying, reduction or enlargement, and exposure adjustments.

	Page
● COPYING FROM THE PLATEN GLASS	24
● COPYING FROM THE RSPF	26
About reversing single pass feeder (RSPF)	26
Using the RSPF	26
● TWO-SIDED COPYING	28
Two-sided copies from one-sided originals	28
Two-sided copies from two-sided originals	31
One-sided copies from two-sided originals	32
● EXPOSURE ADJUSTMENT	34
● REDUCTION/ENLARGEMENT/ZOOM	36
Automatic selection	36
Manual selection	38
● ROTATION COPYING	40
● BYPASS FEED (special paper)	41
Acceptable paper for copying from the bypass tray	41
Copying from the bypass tray	41
● INTERRUPTING A COPY RUN	44

COPYING FROM THE PLATEN GLASS

The basic copying procedure is described below.

- Image loss (max. 5/32" (4 mm)) can occur at the leading and trailing edges of the copies. Also image loss (max. 1/8" (3 mm)) can occur along the other edges of the copies.

NOTE:

If the copier has been programmed in the auditing mode, enter a 5-digit account number. See page 20.

- 1 Place an original face down on the platen glass and align it with the original size scale.**

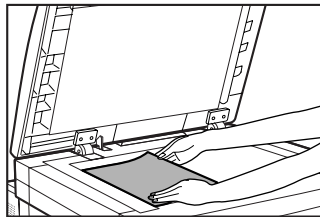

- The detected original size will be indicated in the display.

NOTE:

If the original size cannot be detected, the original size can be entered as follows. Press the SPECIAL FUNCTION key. Use the ▲ and ▼ keys to select "ORIG. SIZE ENTER" and then press the OK key. Use the ◀ and ▶ key to select "AB" or "INCH" and use the ▲ and ▼ keys to select the desired original size. Press the OK key.

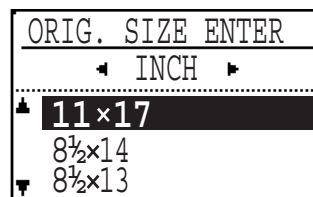

- 2 Close the platen cover.**

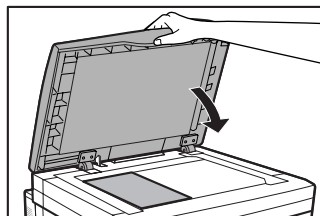

- Paper matching the size of the original will be automatically selected when the auto paper select function has been enabled. To copy onto paper of a different size, press the PAPER SELECT key.
- Paper of the different orientation may be selected if the auto paper select or auto image function has been selected. In this case, the image of the original will be rotated and copied. See page 40.
- ★ **KEY OPERATOR** The auto paper select function can be disabled using a key operator program. If this function is disabled, use the PAPER SELECT key to select the desired paper tray. See page 15 of the KEY OPERATOR'S GUIDE.

3 Ensure that the desired paper tray is selected.

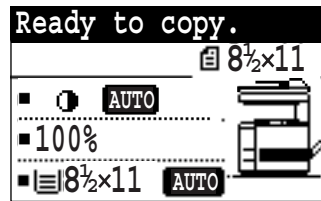

4 Set the number of copies using the numeric keys.

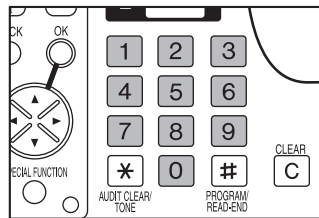

- A single copy can be made even when "0" is displayed.
- Press the CLEAR (C) key to clear an entry if a mistake is made.

5 Press the START (↕) key.

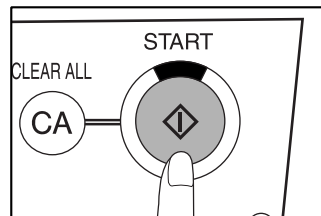

- The number in the copy quantity display will decrease by 1 each time a copy is made.
- To repeat the same copy sequence for a different original, simply replace the original and press the START (↕) key.
- Press the CLEAR (C) key to stop copying in the middle of a run.

NOTES:

- When copying a book or an original which has been folded or a crumpled original, press down lightly on the RSRF. This will reduce shadow lines caused by uneven contact between the original and the platen glass.
- The capacity of the center tray is 500 sheets (400 sheets for 11" x 17", 8-1/2" x 14", A3, and B4 sizes). When the offset function is turned on, a maximum of 350 sheets can be loaded. When the number of copies output reaches this limit, copying will stop and the START (↕) key indicator will go out. Remove the copies from the center tray and press the START (↕) key to resume copying.

COPYING FROM THE RSPF

About reversing single pass feeder (RSPF)

The reversing single pass feeder (RSPF) hold up to 40 originals each for automatic document feeding. If the RSPF is being used, two-sided originals can be copied automatically without having to manually turn them over.

Acceptable originals

Up to 40 originals ranging from 5-1/2" x 8-1/2" to 11" x 17" and from 15 lbs. to 23 lbs. can be used. The total aggregate thickness must not exceed 5/32".

NOTES:

- Be sure to remove any staples or paper clips from the originals.
- Before placing curled or wavy originals into the document feeder tray, be sure to flatten them. If not, original misfeeds may result.
- For best feeding of originals which have binding holes punched into them, insert them so that the holes are positioned to the right or along the original guides. In this case the settings for margin shift may need to be changed. See page 51.

Unacceptable originals

The following types of paper cannot be used as originals:

- Special papers including transparency film, photographs, and tracing paper
- Damaged or crumpled originals
- Paper with multiple punched holes (paper with two or three holes can be used)
- 5-1/2" x 8-1/2" size originals cannot be used in the 2-sided to 1-sided or 2-sided to 2-sided mode.

Stream feeding mode

If the stream feeding mode has been enabled using a key operator program, the message "Set originals for stream feeding." will appear for approximately 5 seconds after feeding of all originals is completed. While this message is displayed, any new originals placed in the RSPF will be fed and copied automatically.

★ **KEY OPERATOR** See page 10 of the KEY OPERATOR'S GUIDE for information on setting the stream feeding mode.

Using the RSPF

1 Ensure that no original is left on the platen glass.

2 Adjust the original guides to the size of the originals.

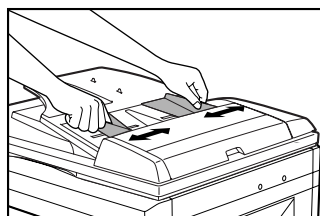

3 Set the originals face up in the document feeder tray.

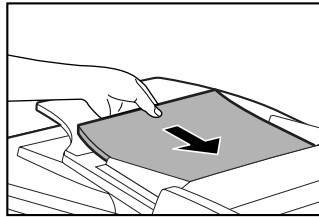

- The original size will be indicated in the display, and the paper tray with the corresponding paper size will be automatically selected.
- ★ **KEY OPERATOR** The auto paper select function can be disabled using a key operator program. If this function has been disabled, use the PAPER SELECT key to select the desired paper tray. See page 15 of the KEY OPERATOR'S GUIDE.
- To copy onto a different size paper, use the PAPER SELECT key to make the selection.

4 Ensure that the one-sided to one-sided copying mode is selected.

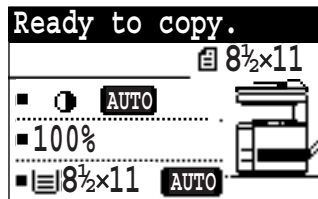

- When no icon indicating a 2-sided copy mode is displayed, the one-sided to one-sided copying mode is selected.

5 Set the number of copies and press the START (↕) key.

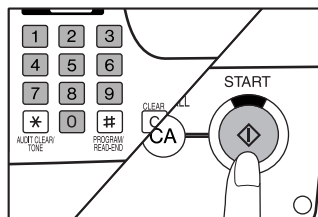

- Press the CLEAR (C) key to stop copying in the middle of a run.

TWO-SIDED COPYING

Two-sided copies can be made by manually placing originals on the platen glass as described in the procedure below. Fully automatic two-sided copies can be made from one-sided originals. Additionally, fully automatic two-sided copying of two-sided originals or one-sided copying of two-sided originals can be made.

NOTES:

- Paper sizes that can be used are 8-1/2" x 11", 8-1/2" x 11"R, 8-1/2" x 13", 8-1/2" x 14", 11" x 17", A5, B5, B5R, A4, A4R, B4, and A3.
- The image for the second side can be rotated 180° top to bottom to allow tablet type binding.

Two-sided copies from one-sided originals

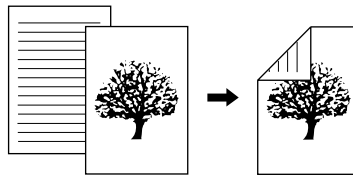

Using the RSPF

- Paper sizes that can be used in the duplex copy mode are 8-1/2" x 11", 8-1/2" x 11"R, 8-1/2" x 13", 8-1/2" x 14", and 11" x 17" (A5, B5, B5R, A4, A4R, B4, and A3).

- 1 Ensure that no original is left on the platen glass. Adjust the original guides to the size of the originals and set the originals face up in the document feeder tray.**

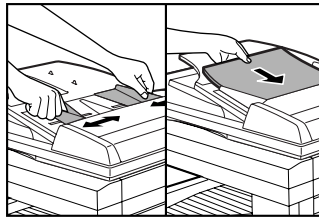

- If an uneven number of originals are set, the last copy will be one-sided.

- 2 Press the 2-SIDED COPY key.**

- The 2-sided copy mode selection screen will appear.

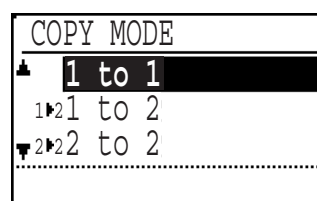
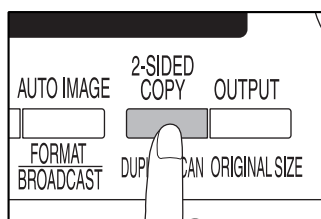

3 Use the ▲ and ▼ keys to select one-sided to two-sided copying.

- Also the 2-SIDED COPY key can be used to select a 2-sided copy mode.

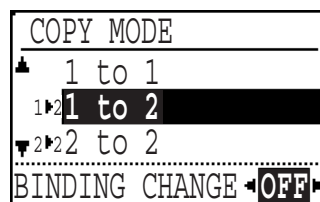
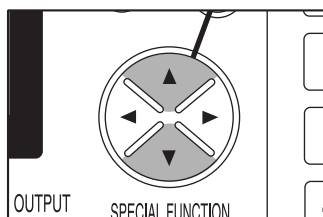
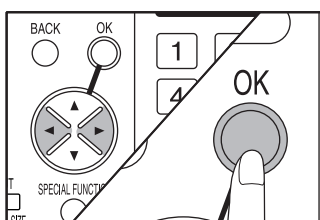
**4 Use the ◀ or ▶ key to select binding change if desired. Then, press the OK key.**

- The image of one side can be rotated 180° using the image rotation feature. This feature can be useful depending on the orientation of the original image and the desired binding position.

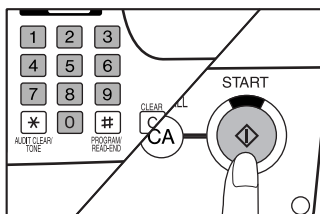
5 Set the number of copies and press the START (◊) key.

- Press the CLEAR (C) key to stop copying in the middle of a run.

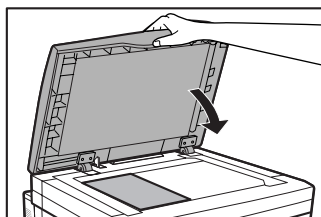
Using the platen glass**1 Place the first original face down on the platen glass and close the RSPF.**

TWO-SIDED COPYING

2 Press the 2-SIDED COPY key.

- The 2-sided copy mode selection screen will appear.

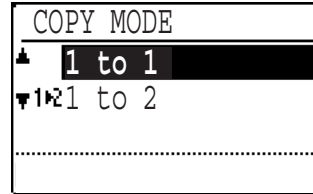
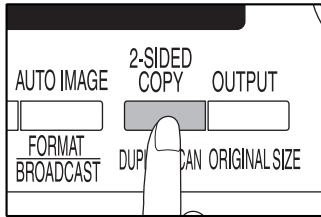

3 Use the ▲ and ▼ keys to select one-sided to two-sided copying.

- Also the 2-SIDED COPY key can be used to select a 2-sided copy mode.

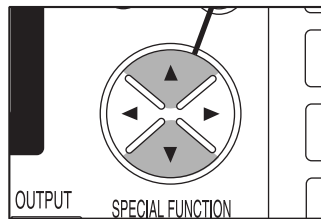

4 Use the ◀ or ▶ key to select binding change if desired. Then, press the OK key.

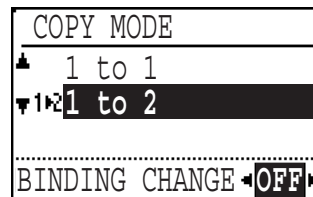
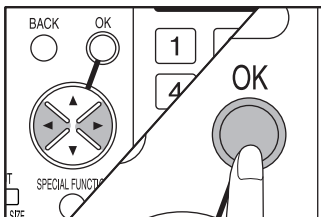

5 Ensure that the desired paper tray is selected.

- Paper sizes that can be used in the 2-sided copy mode are 8-1/2" x 11", 8-1/2" x 11"R, 8-1/2" x 13", 8-1/2" x 14", 11" x 17", A5, B5, B5R, A4, A4R, B4, and A3.
- Neither the bypass tray nor 5-1/2" x 8-1/2" paper can be used for duplex copying.

6 Set the number of copies and press the START (◀▶) key.

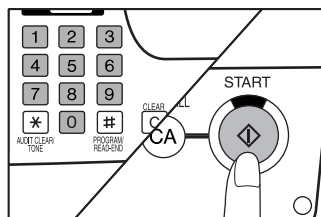

- 7** Place the second original face down on the platen glass and press the **START** (◀▶) key again.

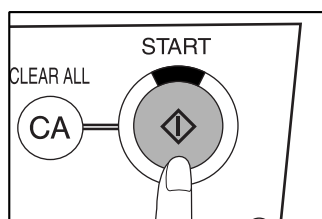

- To stop a copy run during duplex copying, press the CLEAR (C) key.
- To cancel the 2-sided copy mode, press the 2-SIDED COPY key, select the one-sided to one-sided mode, and press the OK key.
- If an uneven number of originals are being copied, press the READ-END key after the last original is scanned. The last copy will be output single-sided.

Two-sided copies from two-sided originals (Only when a RSPF is being used.)

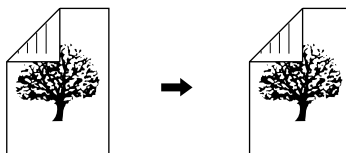

- Paper sizes that can be used in the 2-sided copy mode are 8-1/2" x 11", 8-1/2" x 11"R, 8-1/2" x 13", 8-1/2" x 14", 11" x 17", A5, B5, B5R, A4, A4R, B4, and A3.

- 1** Ensure that no original is left on the platen glass. Adjust the original guides to the size of the originals and set the originals face up in the document feeder tray.

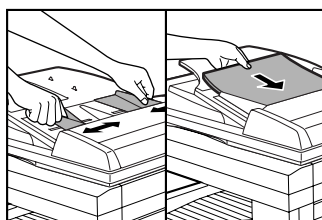

- 5-1/2" x 8-1/2" size originals cannot be used.

- 2** Press the **2-SIDED COPY** key.

- The 2-sided copy mode selection screen will appear.

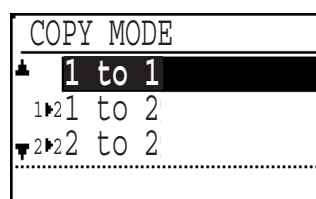
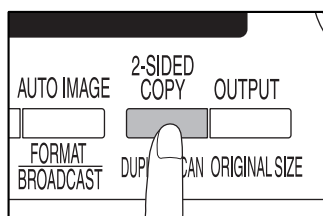

TWO-SIDED COPYING

3 Use the ▲ and ▼ keys to select two-sided to two-sided copying and press the OK key.

- Also the 2-SIDED COPY key can be used to select a 2-sided copy mode.

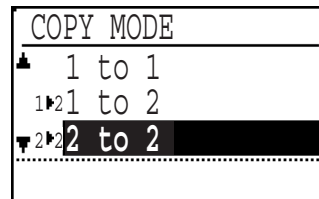
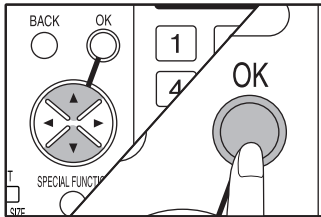

4 Set the number of copies and press the START (↕) key.

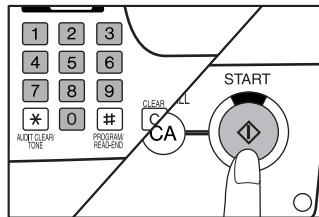

- Be sure not to touch the originals as they move on the reversing tray. This may cause misfeeds.

One-sided copies from two-sided originals (Only when a RSPF is being used.)

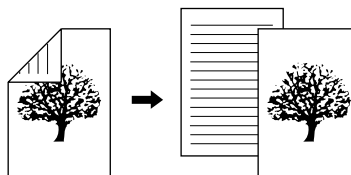

1 Ensure that no original is left on the platen glass. Adjust the original guides to the size of the originals and set the originals face up in the document feeder tray.

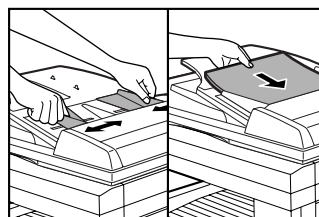

- 5-1/2" x 8-1/2" size originals cannot be used.

2 Press the 2-SIDED COPY key.

- The 2-sided copy mode selection screen will appear.

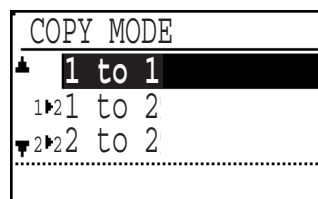
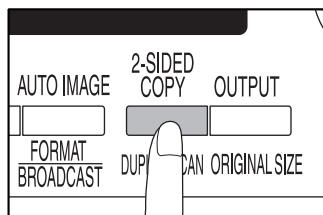
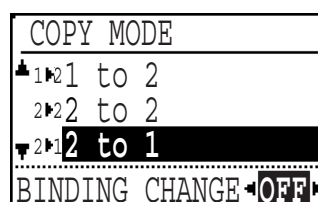
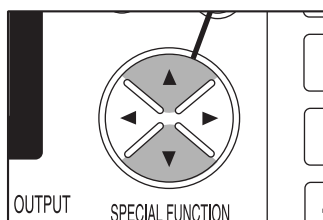
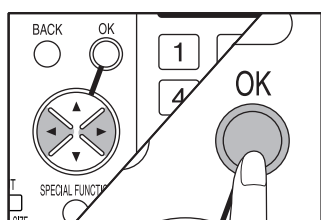
**3 Use the ▲ and ▼ keys to select two-sided to one-sided copying.****4 Use the ◀ or ▶ key to select binding change if desired. Then, press the OK key.**

- The image of one side can be rotated 180° using the image rotation feature. This feature can be useful depending on the orientation of the original image and the desired binding position.

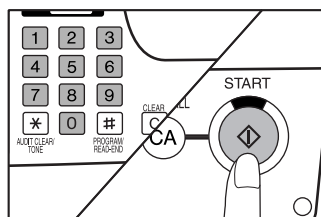
5 Set the number of copies and press the START (◀▶) key.

- Press the CLEAR (C) key to stop copying in the middle of a run.
- Be sure not to touch the originals as they move on the reversing tray. This may cause misfeeds.

EXPOSURE ADJUSTMENT

This copier has four exposure modes to choose from: AUTO, TEXT, TEXT/PHOTO, and PHOTO.

Auto

This is the standard initial setting for this copier. In this mode, the characteristics of an original being copied are "read" by the exposure system, and exposure adjustments are made automatically. This optimizes the contrast of the copied images by reducing the effect of colored or shaded background areas.

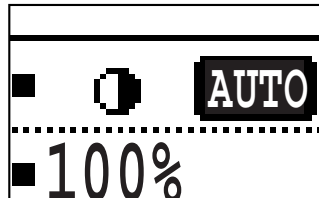

Text, text/photo, and photo

Text mode: This mode is useful for enhancing very low density areas of an original or suppressing unusually high-density background areas.

Text/photo mode: This mode provides the best balance for copying an original which contains both text and photos. This mode is also useful for copying printed photographs.

Photo mode: This mode is good for copying photographs with fine details.

1 Press the EXPOSURE key.

- The exposure adjustment screen will appear.

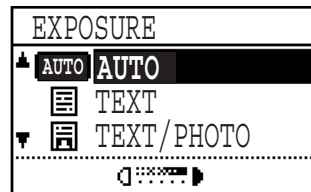
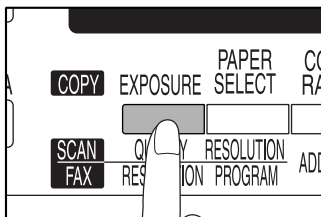

2 Use the ▲ and ▼ keys to select "TEXT", "TEXT/PHOTO" or "PHOTO" depending on the type of original to be copied.

- Also the EXPOSURE key can be used to select an exposure mode.

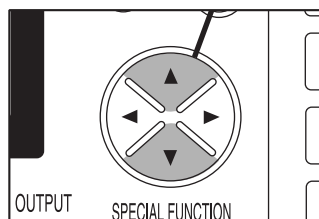

3 Use the ◀ and ▶ keys to adjust the copy density as desired.

- Copy density cannot be adjusted manually in the AUTO exposure mode.

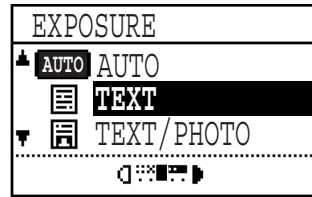
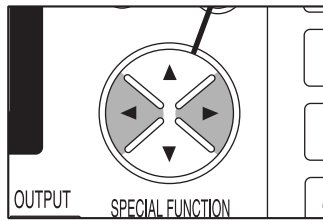

4 Press the OK key.

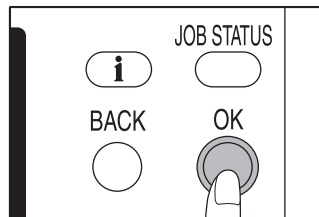

- To return to the AUTO mode, press the EXPOSURE key, use the ▲ and ▼ key to select "AUTO", and press the OK key.

REDUCTION/ ENLARGEMENT/ZOOM

Reduction and enlargement ratios can be selected either automatically with the AUTO IMAGE key or manually with the COPY RATIO key. The zoom function enables precise copy ratio selection from 25% to 400% in 1% increments.

NOTE:

When using the RSPF, the zoom range is 50% to 200%.

Automatic selection

- When the auto image function is enabled, the reduction or enlargement ratio cannot be selected manually.

1 Place an original on the platen glass and close the platen cover.

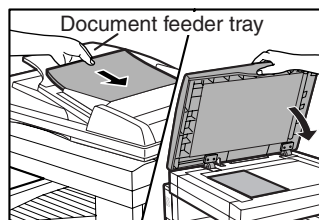

- The original size will be automatically detected and indicated in the display. If the original is a non-standard size, it cannot be detected. In this case, press the SPECIAL FUNCTION key to enter the original size. See page 24.

2 Use the PAPER SELECT key to select the paper tray with the desired paper size.

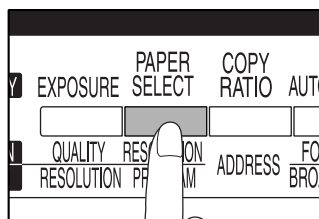

- This feature will not work when copy paper of non-standard size is used.

3 Press the AUTO IMAGE key.

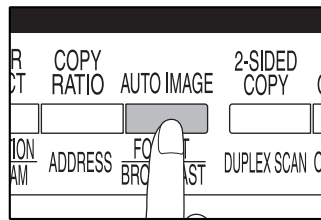

- The copy ratio will be automatically set.
- If the original and the selected copy paper are not in the same orientation, the image will be automatically rotated to match the copy paper. However, if enlargement is selected for copying onto a paper size larger than 8-1/2" x 11" (A4), the image will not be rotated. In this case a message indicating "Image edge loss" will appear.
- ★ **KEY OPERATOR** Rotation of the image can be disabled using a key operator program. See page 10 of the KEY OPERATOR'S GUIDE.
- If the message "Image edge loss" is displayed, part of the original image may not be copied.

4 Enter the number of copies and press the START (◀▶) key.

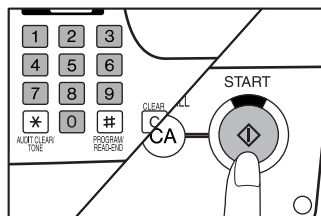

- To cancel the automatic reduction/enlargement mode, press the AUTO IMAGE key again.
- When copying from a RSPF, the automatic reduction/enlargement feature will be effective only for the current copy run.

Manual selection

- 1 Place an original on the platen glass and close the platen cover.

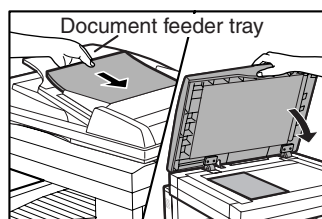

- 2 Press the COPY RATIO key.
 - The copy ratio adjustment screen will appear.

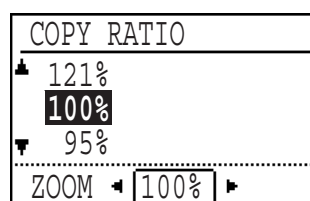
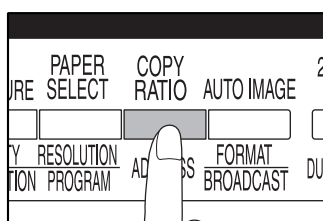

- 3 Use the ▲ and ▼ keys to select a preset copy ratio or use the ◀ and ▶ keys to select a zoom ratio.

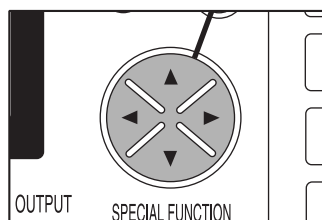

- A.Preset reduction ratios are: 95%, 77%, 64%, 50%, and 25%.
- B.Preset enlargement ratios are: 121%, 129%, 141%, 200%, and 400%.
- C.Zoom ratios: Any ratio from 25% to 400% can be set, in 1% increments. Use the ▲ and ▼ keys to set the approximate ratio, then press the ◀ key to decrease the ratio or the ▶ key to increase the ratio.
 - To decrease or increase the zoom ratio rapidly, press and hold down the ◀ or ▶ key. However the value will stop at the preset reduction or enlargement ratios. To move beyond these ratios, release the key and then press and hold it down again.
- D.Same-size reset: Press the ▲ or ▼ key repeatedly until the copy ratio returns to 100%.

NOTE:

If the COPY RATIO key is pressed, the copy ratio will be reset to 100%.

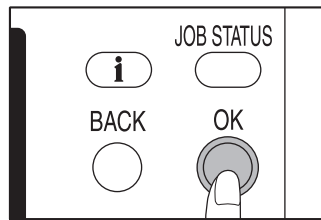
4 Press the OK key.

- The display will return to the basic screen.

5 Ensure that the desired paper tray is selected.

- If the auto paper select function has been enabled, the appropriate copy paper size will have been automatically selected based on the original size and the selected copy ratio.
- If the auto paper select function has been disabled or if copying onto a different size paper, use the PAPER SELECT key to select the paper feed station with the desired paper size.

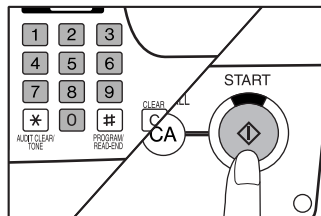
6 Set the number of copies and press the START (◀▶) key.

ROTATION COPYING

If rotation of original image is enabled using a key operator program, the image of the original will rotate when the orientation of the original does not match that of the copy paper. Rotation copying will function only if the auto paper select mode or the auto image mode has been selected. Even if rotation of original image is disabled using a key operator program, rotation copying will function when the 2 in 1 or 4 in 1 function is selected. However, if enlargement copying onto a paper size larger than 8-1/2" x 11" (A4) is performed, the image cannot be rotated. In this case, the original must be rotated 90°. If the margin shift feature is set, rotation copying will not function.

★**KEY OPERATOR** See page 10 of the KEY OPERATOR'S GUIDE for enabling/disabling rotation copying.

Example: Copying from an 11" x 17" original onto 8-1/2" x 11" paper

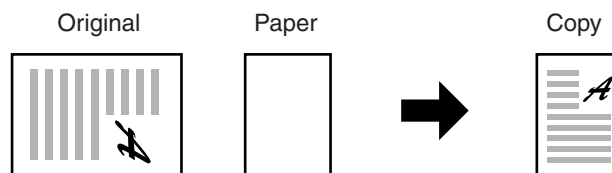

1 Place an original on the platen glass and close the platen cover.

2 Use the PAPER SELECT key to select the desired tray.

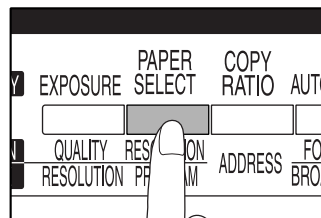

3 Press the AUTO IMAGE key.

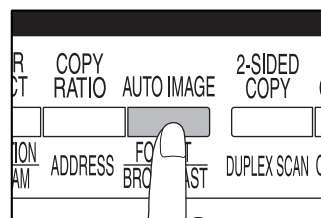

- The appropriate copy ratio will be automatically selected for rotation copying.

4 Set the number of copies and press the START (⏏) key.

NOTE:

Images of originals may also be rotated in the auto paper select mode.

BYPASS FEED (special paper)

The bypass tray must be used to feed special papers such as transparency film and labels but can also be used to feed standard copy paper.

Acceptable paper for copying from the bypass tray

Size	Weight	Capacity (21 lb. bond paper)	Special paper
Ordinary paper: 5-1/2" x 8-1/2" to 11" x 17"	14 lbs. to 34 lbs.* (Ordinary paper)	100 sheets	Transparency film, labels, envelopes**
Envelopes: Commercial 10 (4-1/8" x 9-1/2"), International DL (110 x 220 mm), International C5 (162 x 229 mm)			

* For paper weighing from 28 to 34 lbs., 8-1/2" x 11" is the maximum size that can be fed through the bypass tray.

**Do not use envelopes that have metal clasps, plastic snappers, string closures, windows, linings, self-adhesive patches or synthetic materials. These will cause physical damage to the copier.

- For best results, use only paper recommended by SHARP.
- Special papers except SHARP recommended transparency film, labels, and envelopes must be fed one sheet at a time through the bypass tray. Up to 40 sheets of SHARP recommended transparency film and labels can be set at one time. Up to 5 envelopes can be set at one time.
- When feeding two or three hole prepunched paper, load the paper so that the punched edge is not positioned in the feed slot.

Copying from the bypass tray

1 Unfold the bypass tray.

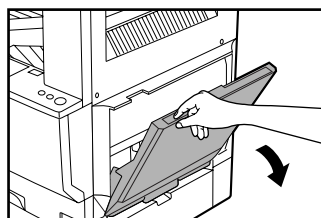

- When feeding 8-1/2" x 11"R, 8-1/2" x 14" or 11" x 17" sized paper, extend the bypass tray to support the paper.

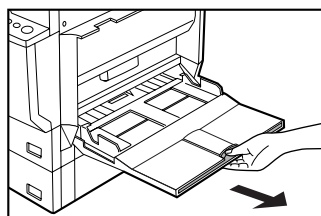

BYPASS FEED (special paper)

2 Set the paper guides to the copy paper width.

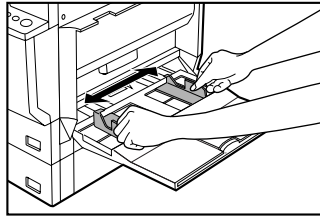

3 Insert the copy paper (print face down) all the way into the bypass tray.

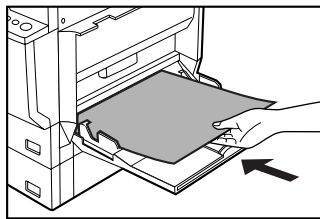

- For the number of sheets which can be loaded into the tray, see the previous page.
- When adding paper, first remove any paper remaining in the tray, combine it with the paper to be added and then reload as a single stack. The paper to be added must be the same size and type as the paper already in the tray.
- When loading envelopes, make sure that they are straight and flat and do not have loosely glued construction flaps (not the closure flap).

4 Press the PAPER SELECT key to select the bypass tray.

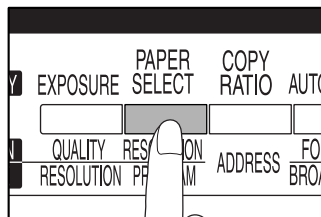

NOTE:

When copying onto paper that is fed from the bypass tray, the print start position in the vertical direction can be adjusted as follows. Press the SPECIAL FUNCTION key. Use the ▲ and ▼ key to select "EXTRA IMAGE ADJ." and then press the OK key. Use the ▲ and ▼ key to adjust the print start position to the front (+) or to the rear (-). Press the OK key. The position can be adjusted from -0.5 inch to +0.5 inch in 0.02 inch increments.

This feature can be used only for extra size paper (indicated as "EXTRA" in the display) placed in the bypass tray and cannot be used for standard size paper.

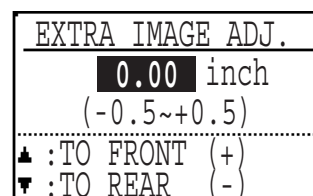

5 Set the number of copies and press the START (⏏) key.

NOTE:
The bypass tray can be used to copy onto the two sides of paper manually.
When copying the second original, be sure to turn over the copy of the first original left to right and place it into the bypass tray as shown in the illustration.

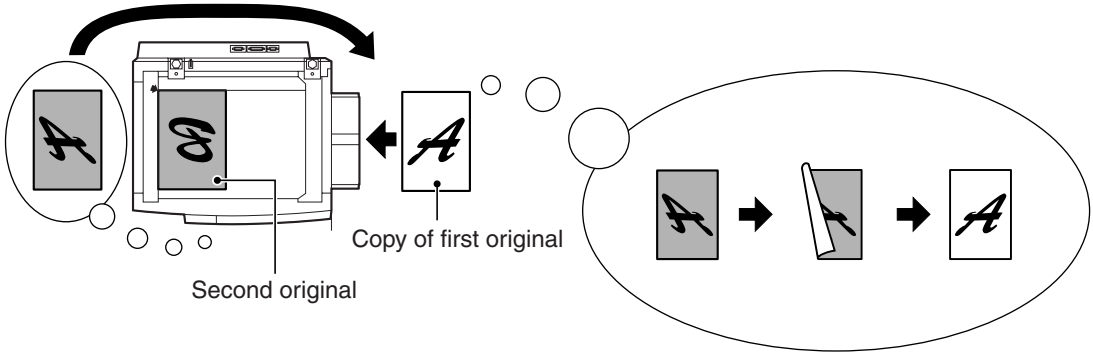

INTERRUPTING A COPY RUN

INTERRUPT is used to interrupt a long copy run so that another job can be done.

- Two-sided and 2 in 1/ 4 in 1 copying jobs cannot be interrupted.
- Two-sided copying, sort, group, staple sort, job programs and 2 in 1/ 4 in 1 cannot be selected for interrupt copying. Key operator programs cannot be used in the interrupt mode.

1 Press the INTERRUPT (≡) key.

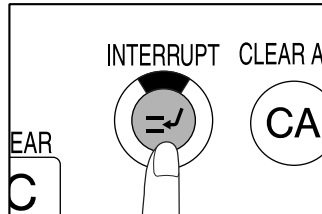

- If INTERRUPT is pressed during copying from the platen glass, the copier will stop and return to the initial settings after the copy in progress has been completed.
- If INTERRUPT is pressed during copying when a RSPF is being used, the copier will stop after completing copying of any original which has been fed by the RSPF.
- If this copier has been programmed in the auditing mode, the account number entry message will appear. Enter your account number using the numeric keys. The number of copies of the interrupt copying will be accumulated against this account number. See page 20.

2 When the copier stops, remove the original(s) of the current job and set an original for interrupt copying.

3 Select the desired available copier functions.

4 Set the number of copies and press the START (⇩) key.

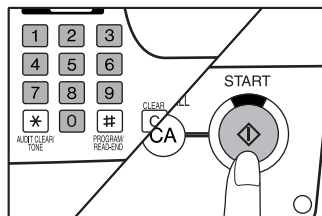

- The interrupt copies will be offset from the previous copies unless the offset function is disabled.
- ★ **KEY OPERATOR** See page 11 of the KEY OPERATOR'S GUIDE for the offset function.

- 5** When all INTERRUPT copies are finished, press the INTERRUPT (=) key again to cancel the INTERRUPT mode, and remove the original used for interrupt copying.

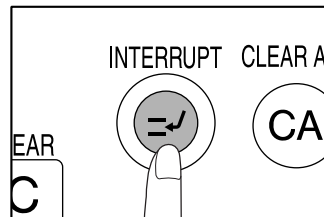

- All settings for the interrupted job will be automatically restored.

- 6** Replace the original(s) for the interrupted job and press the START (◊) key to resume copying.

CHAPTER 3

SPECIAL FUNCTIONS

This chapter describes special copying functions including various image editing functions.

	Page
● SORT/GROUP	48
Copying in the sort or group mode	48
● MARGIN SHIFT	51
● ERASE	53
● DUAL PAGE COPY	55
● 2 IN 1 OR 4 IN 1	57
● B/W REVERSE	60
● XY ZOOM	62
● TRANSPARENCY	65
● JOB MEMORY	67
Storing a job program	67
Deleting a job program	68
Recalling a job program	69

SORT/GROUP

The copier has two sorter modes for different copying jobs: one sorts copies into sets matching the sequence of the originals and the second groups copies by originals.

Sort mode

Sets of copies will be sequentially delivered to the center tray.

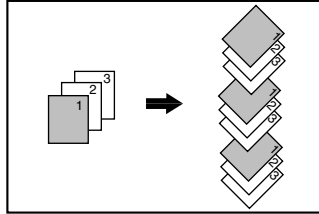

Group mode

Multiple copies of each original will be grouped in the center tray.

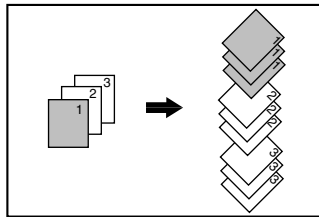

Copying in the sort or group mode

When copying from the platen glass in the sort or group mode or from the document feeder tray in the group mode, original images will be stored in the copier memory each time an original is scanned and copying will start after all originals have been scanned. However, if originals are set in the document feeder tray and the sort mode is selected, copying will start immediately after the first original is scanned.

- 1 Place an original on the platen glass or in the document feeder tray.**

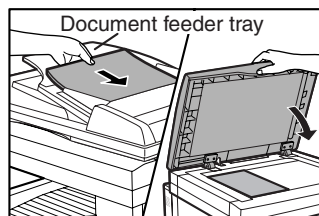

- If originals are placed in the document feeder tray, the sort mode will be automatically selected. This setting, however, can be canceled using a key operator program.

2 Press the OUTPUT key.

- The output mode selection screen will appear.

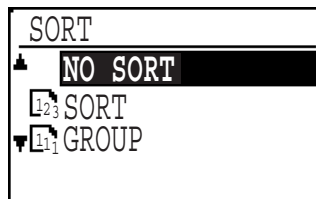
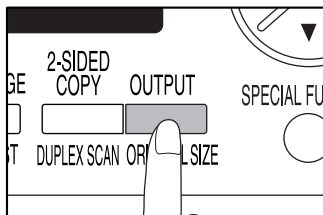

3 Use the ▲ and ▼ keys to select the desired output mode and press the OK key.

- Also the OUTPUT key can be used to select an output mode.

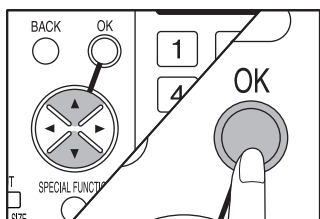

4 Make all other desired copier selections and press the START (◊) key.

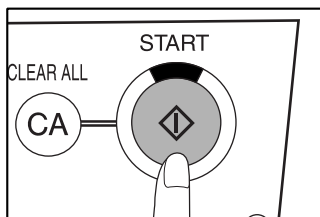

- If originals have been set in a RSPF in step 1, copying will start. If an original has been set on the platen glass, proceed to the next step.

5 Replace the finished original with the next original and press the START (◊) key after it lights up. Repeat this step until all originals have been scanned.

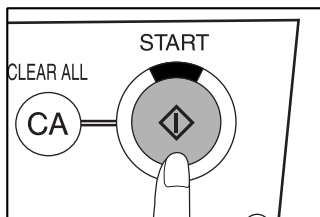

- If the non-sort mode has been selected in step 3, copying will start each time the START (◊) key is pressed.



6 After all originals have been scanned, press the READ-END key.

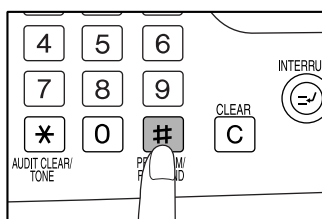

- Copying will start.
- If the memory becomes full of scanned original image data, a warning message will appear. Press the START (↕) key to start copying the data in memory or the CLEAR ALL (CA) key to cancel copying.
- The memory can be extended to a maximum of 272 MB to increase the capacity for storing image data by adding commercially available memory modules. Please contact your service center for details.

Offset stack

If the offset stack mode is enabled using a key operator program, each copy set will be offset by approximately 1 inch (25 mm) from the previous set. When copying in the sort mode, collated sets of copies will be made and each collated set of copies produced will be stacked offset from the previous set in the center tray. When copying in the group mode, groups of multiple copies from the same original will be made and each group produced will be stacked offset from the previous group in the center tray.

If the offset stack mode is disabled, copies will not be offset.

The offset stack mode is enabled in the factory default setting.

★ **KEY OPERATOR** See page 11 of the KEY OPERATOR'S GUIDE for the offset function.

MARGIN SHIFT

The MARGIN SHIFT feature, in its initial setting, automatically shifts the text or image to increase the margin by approximately 1/2".

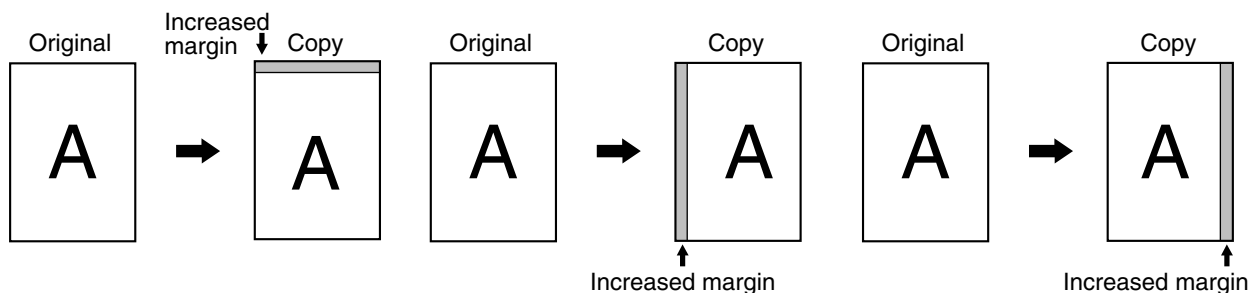

- The location of the margin to be increased can be selected at the left edge, the right edge or the top edge of the page. To select the location, see step 4 overleaf.
 - When making two-sided copies with this function, the margin on both sides will be increased in the same way.
 - This feature cannot be used with the 2 in 1 or 4 in 1 feature and rotation copying.
 - This feature cannot be used with non-standard size copy paper.
 - The standard shift amount is 1/2", but can be changed from 1/4" to 1" in 1/4" increments.
- ★**KEY OPERATOR** The initial shift setting can be changed from 1/4" to 1" in 1/4" increments. See page 9 of the KEY OPERATOR'S GUIDE.

1 Place an original on the platen glass or in the document feeder tray.

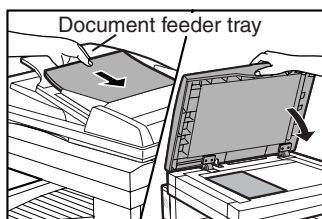

- When copying from the platen glass and the margin is to be increased on the left side, set the original face down so that the margin side is positioned to the right. If the margin is to be increased on the right side, set the original face down so that the margin side is positioned to the left.
- If top is selected, set the original so that the margin to be increased is set to the rear side of the platen glass or the document feeder tray.

2 Press the SPECIAL FUNCTION key. Then press the OK key.

- The SPECIAL MODES screen will appear with MARGIN SHIFT highlighted.

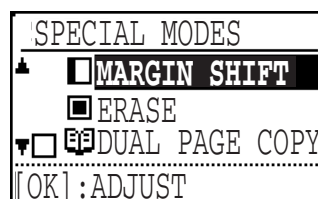
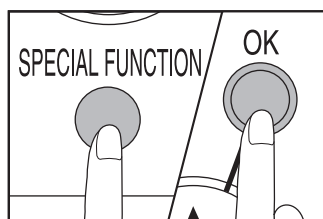

MARGIN SHIFT

3 Press the OK key.

- The setting screen for MARGIN SHIFT will appear.



4 Use the ▲ and ▼ keys to select the shift direction and the ◀ and ▶ keys to select the shift amount.

- Select the shift direction from DOWN, RIGHT, and LEFT.
- Select the shift amount from 1/4", 1/2", 3/4", and 1".

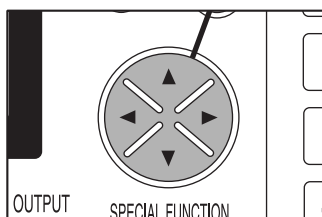

5 Press the OK key.

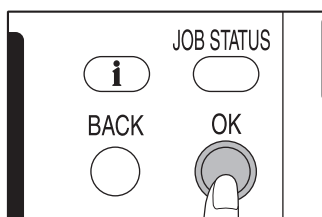

- The display will return to the basic screen.

6 Make all other desired copier selections and press the START (◊) key.

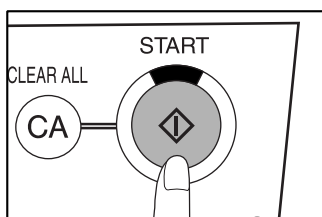

- To cancel the margin shift feature, select the margin shift feature again and select "OFF".

ERASE

This copier has an edge erase mode and a center erase mode.

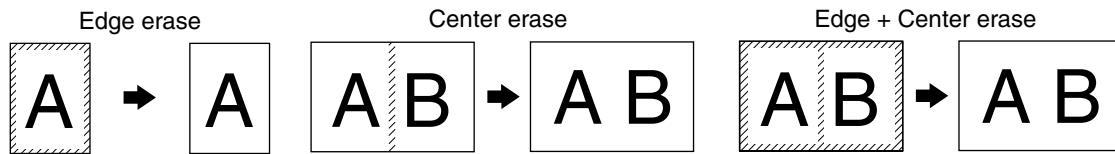

- Edge erase can be used to eliminate shadow lines around the edges of copies which appear when thick paper or a book is used as an original.
- Center erase can be used to eliminate the shadow produced by the bindings of bound documents.
- Edge + center erase can be used together to eliminate both types of shadow lines.
- The standard erase width is 1/2", but can be changed from 1/4" to 1" in 1/4" increments.
- ★ **KEY OPERATOR** The initial setting of the width for edge erase and center erase can be changed. See page 10 of the KEY OPERATOR'S GUIDE.
- This feature cannot be used with the 2 in 1 or 4 in 1 feature.
- If the dual page copy feature has been set, center erase and edge + center erase cannot be set.
- This feature cannot be used with non-standard size originals.

1 Place an original on the platen glass or in the document feeder tray.

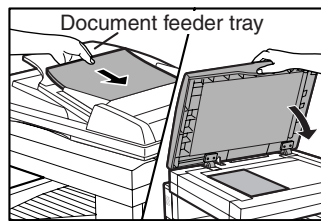

2 Press the SPECIAL FUNCTION key. Then press the OK key.

- The SPECIAL MODES screen will appear.

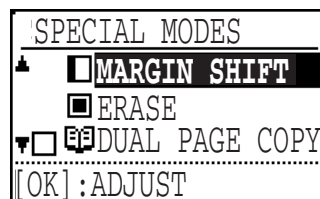
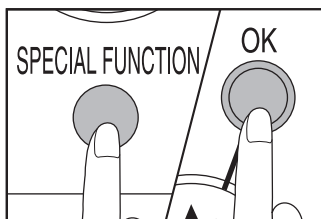

3 Use the ▲ and ▼ keys to select "ERASE" and press the OK key.

- The setting screen for ERASE will appear.

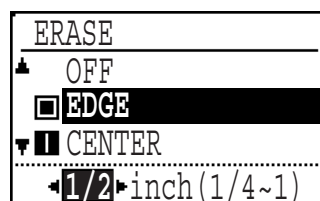
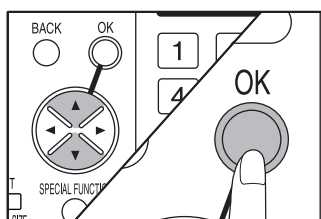

ERASE

4 Use the ▲ and ▼ keys to select the desired erase mode.

- Select "EDGE", "CENTER" or "EDGE + CENTER".

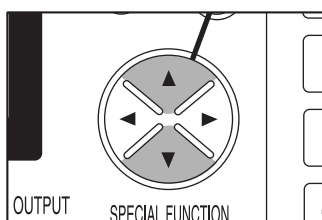

5 Use the ◀ and ▶ keys to adjust the amount of erase if needed.

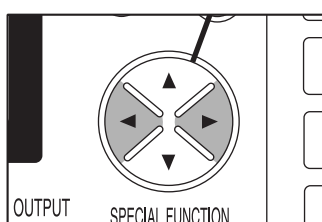

6 Press the OK key.

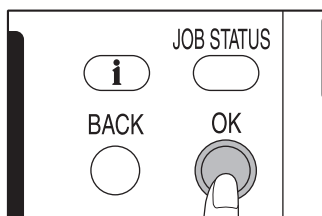

- The display will return to the basic screen.

7 Make all other desired copier selections and press the START (◊) key.

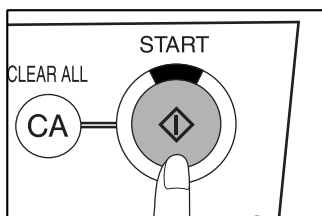

- To cancel the erase feature, select the erase feature again and select "OFF".

DUAL PAGE COPY

The DUAL PAGE COPY feature produces individual copies of two documents placed side by side on the platen glass. It is especially useful when copying books and other bound documents.

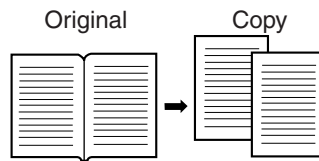

- This feature can be used in the one-sided to two-sided copying mode.
- This feature cannot be used with the 2 in 1 / 4 in 1, center erase, edge+center erase, enlargement or staple sort features.
- If this feature is selected when the auto image feature has been selected, the auto image feature will be canceled.
- When originals are set in a RSPF, this feature cannot be selected.

- 1 Place the originals on the platen glass with the center of the two pages aligned with the paper size index (8½). Close the platen cover.**

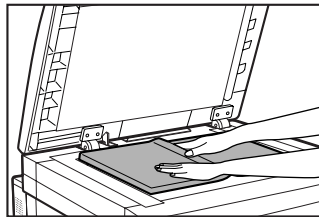

- Set the page to be copied first to the right of the paper size index mark.

- 2 Press the SPECIAL FUNCTION key. Then press the OK key.**

- The SPECIAL MODES screen will appear.

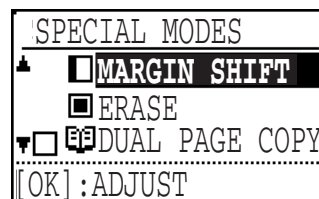
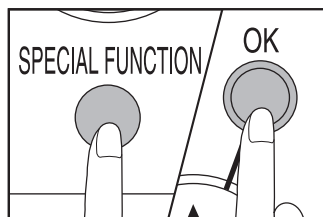

DUAL PAGE COPY

- Use the ▲ and ▼ keys to select "DUAL PAGE COPY" and press the OK key.

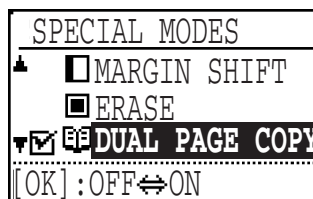
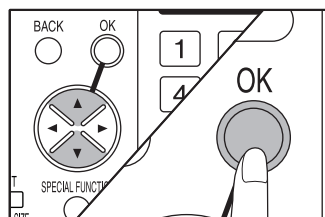

- A check mark will appear to the left of "DUAL PAGE COPY", and the display will return to the basic screen.

- Check to be sure that 8-1/2" x 11" sized copy paper is selected.

- 8-1/2" x 11"R paper can also be used if the auto paper select mode is selected and rotation copying has been enabled.

- Make all other desired copier selections and press the START (◊) key.

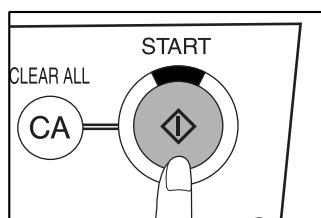

- To cancel the dual page copy feature, highlight "DUAL PAGE COPY" with a check mark on the SPECIAL MODES screen and press the OK key.

2 IN 1 OR 4 IN 1

The 2 in 1 or 4 in 1 feature is used to copy 2 or 4 originals, collectively in a specified order, onto one sheet.

2 in 1 copying

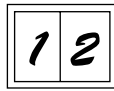

Pattern ①

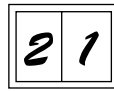

Pattern ②



Pattern ①

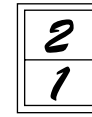

Pattern ②

4 in 1 copying

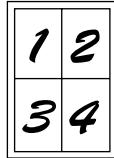

Pattern ①

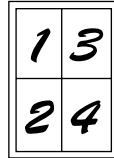

Pattern ②

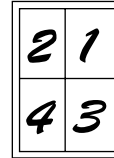

Pattern ③



Pattern ④

- These features cannot be used with the dual page copying, XY zoom, erase or margin shift features.
- Copies can be made with or without the border lines.
- The order of originals which will be arranged on the copies can be selected. There are two patterns of layout for 2 in 1 copying and four patterns of layout for 4 in 1 copying.
- Non-standard size paper cannot be used with the 2 in 1 or 4 in 1 feature.
- If this feature is set, the copy ratio will be automatically set and cannot be changed manually.
- The 2 in 1 or 4 in 1 feature cannot be set for interrupt copying. While 2 in 1 or 4 in 1 is being set, interrupt will not function.

1 Place an original on the platen glass or in the document feeder tray.

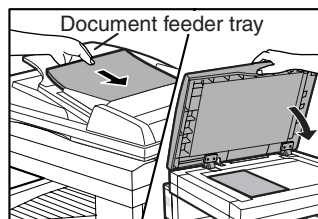

2 Use the PAPER SELECT key to select the paper tray with the desired paper size.

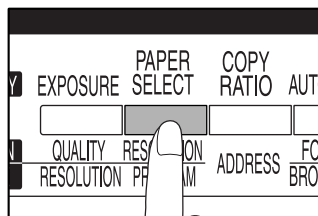

3 Press the SPECIAL FUNCTION key. Then press the OK key.

- The SPECIAL MODES screen will appear.

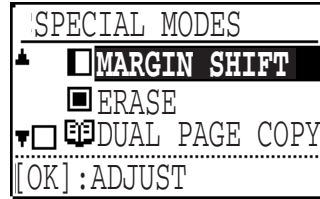
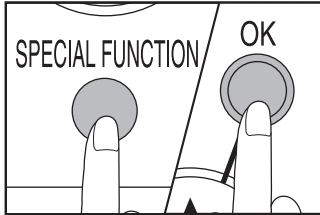

4 Use the ▲ and ▼ keys to select "2in1/4in1" and press the OK key.

- The selection screen for 2 in 1 / 4 in 1 will appear.

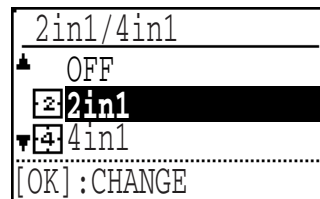
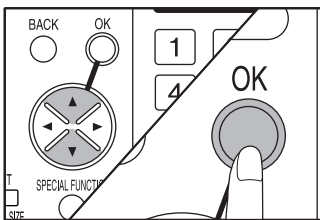

5 Use the ▲ and ▼ keys to select "2in1" or "4in1" and press the OK key.

- The setting screen for 2 in 1 or 4 in 1 will appear.

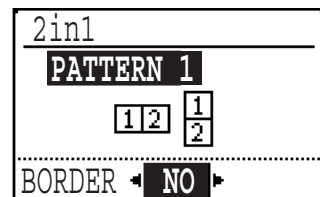
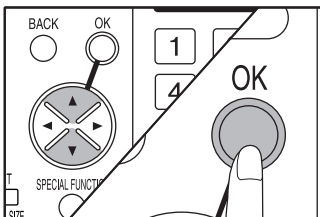

6 Use the ▲ and ▼ keys to select the desired layout pattern.

- Select the order of originals which will be arranged on the copies. For layout patterns, see the previous page.

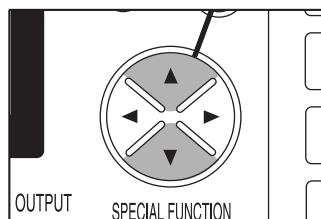

7 Use the ◀ and ▶ keys to select a type of border line.

- Select the solid line, broken line or no border line.

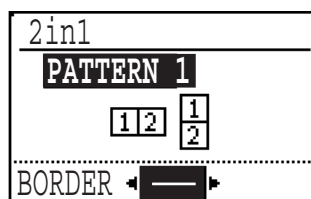
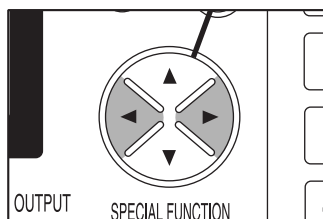
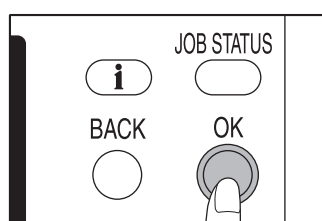
**8 Press the OK key.**

- The display will return to the basic screen.

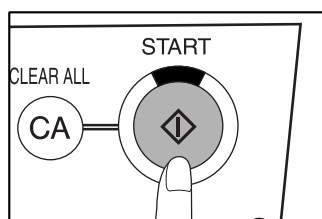
9 Make all other desired copier selections and press the START (◊) key.

- The copy ratio will be calculated automatically.
- If a RSPF is used, copying will start after originals are scanned.
- If the platen glass is used, proceed to the next step.

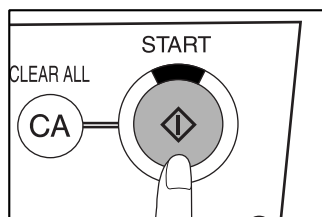
10 Replace the finished original with the next original and press the START (◊) key after it lights up. Repeat this step until all originals have been scanned.

- Copies will be output each time two originals for 2 in 1 copy or four originals for 4 in 1 copy have been scanned.
- To start copying before scanning all originals for a copy (after only one original for 2 in 1 or three originals or less for 4 in 1 have been scanned), press the READ-END key.
- Portions of original images may not be copied depending on the original and copy paper sizes and the number of images to be copied onto a page.
- Depending on the number of originals and the orientation of the originals and copy paper, the image of originals may be rotated.
- To cancel the 2 in 1 / 4 in 1 feature, select the 2 in 1 / 4 in 1 feature again and select "OFF".

B/W REVERSE

The B/W REVERSE feature is used to reverse black and white areas.

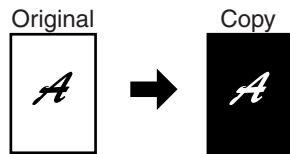

- When the B/W REVERSE feature is selected, the exposure mode will be automatically set to the TEXT mode. Other exposure modes cannot be selected. Even if this feature is canceled, the TEXT mode will not automatically be canceled.

1 Place an original on the platen glass or in the document feeder tray.

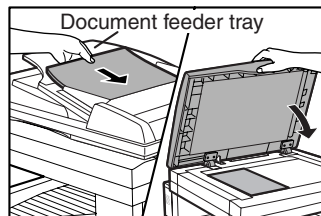

2 Press the SPECIAL FUNCTION key. Then press the OK key.

- The SPECIAL MODES screen will appear.

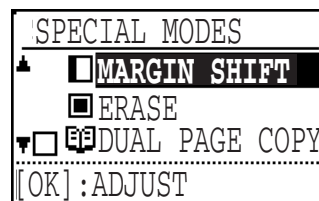
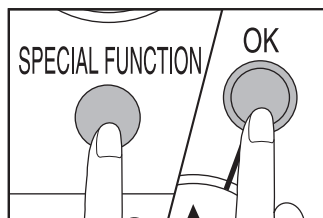

3 Use the ▲ and ▼ keys to select "B/W REVERSE" and press the OK key.

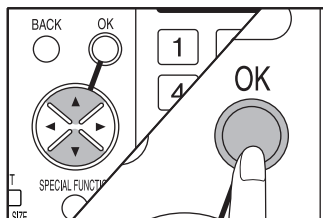

- A check mark will appear to the left of "B/W REVERSE", and the display will return to the basic screen.

-
- 4** Make all other desired copier selections and press the **START** (◊) key.

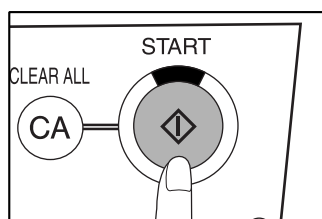

- To cancel the B/W reverse feature, highlight "B/W REVERSE" with a check mark on the SPECIAL MODES screen and press the OK key.

XY ZOOM

The XY ZOOM feature allows the horizontal and vertical copy ratios to be changed independently.

Example: Reduction only in the horizontal direction

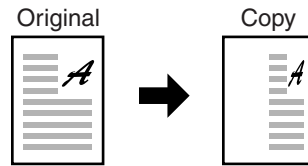

- This feature cannot be used with the 2 in 1 or 4 in 1 feature.
- To use the XY ZOOM feature with the DUAL PAGE COPY feature, set the DUAL PAGE COPY feature first and then the XY ZOOM feature. (Enlargement cannot be set.)
- The copy ratios can be set from 25% to 400%.

NOTE:

When using the RSPF, the zoom range is 50% to 200%.

- If the AUTO IMAGE function has been set, the XY ZOOM feature cannot be set. If the XY ZOOM feature is set, the AUTO IMAGE function cannot be set.

1 Place an original on the platen glass or in the document feeder tray.

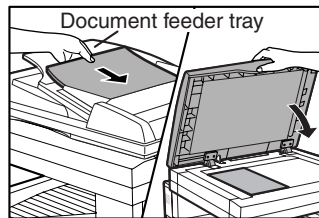

2 Press the SPECIAL FUNCTION key. Then press the OK key.

- The SPECIAL MODES screen will appear.

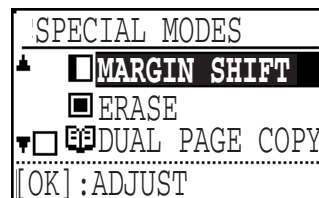
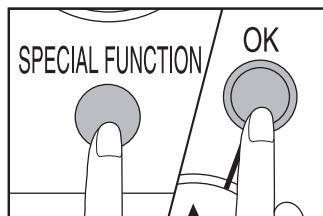

3 Use the ▲ and ▼ keys to select "XY ZOOM" and press the OK key.

- The setting screen for XY ZOOM will appear. The copy ratio in the horizontal direction will be highlighted.

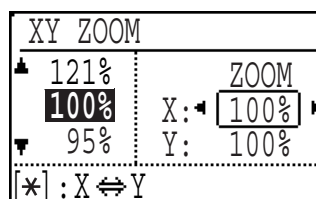
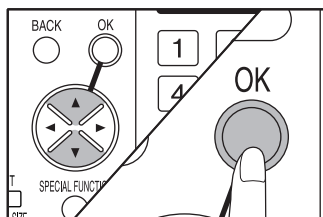

4 Use the ▲, ▼, ◀, and ▶ keys to change the copy ratio in the horizontal direction.

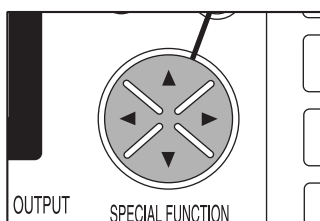

- Use the ▲ and ▼ keys to set the approximate ratio, then press the ◀ key to decrease the ratio or ▶ key to increase the ratio.

5 Press the [*] key.

- The copy ratio in the vertical direction will be highlighted.

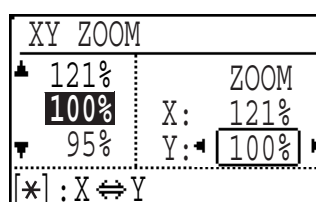
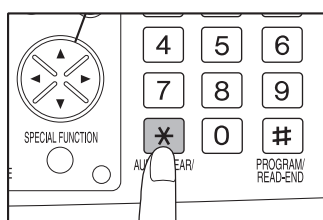

6 Use the ▲, ▼, ◀, and ▶ keys to change the copy ratio in the vertical direction.

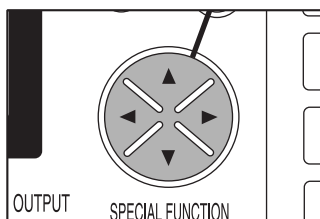

- To change the copy ratio in the horizontal direction again, press the [*] key.

7 Press the OK key.

- The display will return to the basic screen.

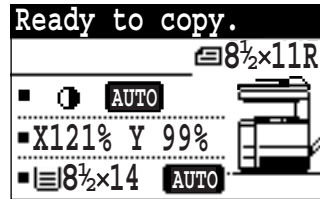
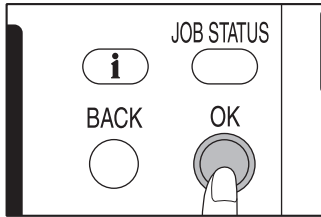

8 Ensure that the desired paper tray is selected.

- If the auto paper select function has been enabled, the appropriate copy paper size will have been automatically selected based on the original size and the selected copy ratios. Image rotation may occur.

9 Make all other desired copier selections and press the START (◀▶) key.

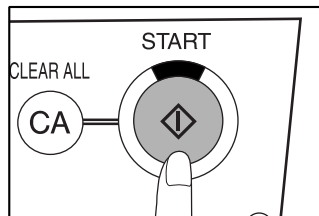

- To cancel the XY zoom feature, press the COPY RATIO key. A confirmation display will appear. Select "OFF" and press the OK key. Set the copy ratio again if needed. If you select "ADJUST" and press the OK key, the copy ratio for XY ZOOM can be set.

TRANSPARENCY

The TRANSPARENCY feature is used to copy onto transparency film.

- When copying onto transparency film, use this feature to obtain better copy quality. When this feature is selected, the bypass tray will be automatically selected and "TRANSPARENCY" will appear in the paper size display.
- This feature cannot be used with duplex copying or staple sort copying.
- Recommended transparency film is SF-85A.

1 Place an original on the platen glass or in the document feeder tray.

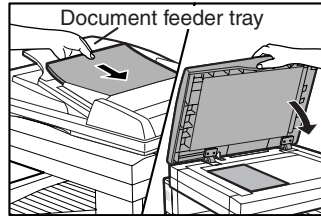

2 Press the SPECIAL FUNCTION key. Then press the OK key.

- The SPECIAL MODES screen will appear.

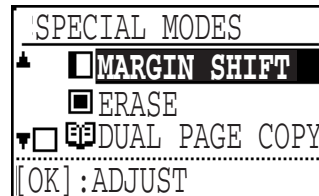
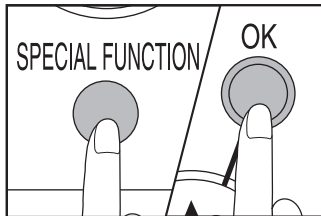

3 Use the ▲ and ▼ keys to select "TRANSPARENCY" and press the OK key.

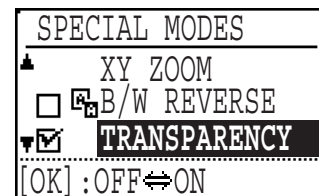
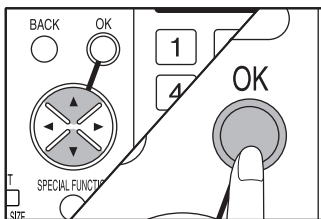

- A check mark will appear to the left of "TRANSPARENCY", and the display will return to the basic screen.

TRANSPARENCY

4 Load transparency film into the bypass tray.

- Load transparency film one sheet at a time in the portrait orientation.

5 Make all other desired copier selections and press the START (◊) key.

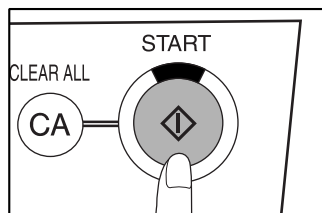

- To cancel the transparency feature, highlight "TRANSPARENCY" with a check mark on the SPECIAL MODES screen and press the OK key.

JOB MEMORY

Nine frequently used job programs can be stored in each of nine storage registers. This is convenient for quick job recall without losing time manually reprogramming each aspect of a job.

- The following functions cannot be stored in the job memory: copy quantity, original size, document station (platen glass or document feeder tray), paper size, interrupt, extra image adjustment.
 - If any function which has been stored in a job program is modified by a key operator program, the key operator settings will supercede the previous setting.
 - The job memory feature cannot be used in the interrupt copy mode.
- ★**KEY OPERATOR** Job memory replacement/deletion can be prohibited. See page 15 of the KEY OPERATOR'S GUIDE.

Storing a job program

1 Make all copier selections to be stored.

2 Press the PROGRAM key.

- The JOB PROGRAMS screen will appear.

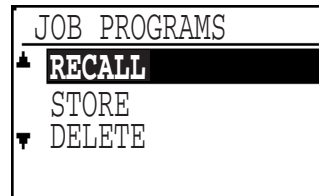
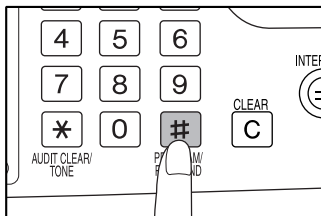

3 Use the ▲ and ▼ keys to select "STORE" and press the OK key.

- The STORE JOB PROGRAM screen will appear.

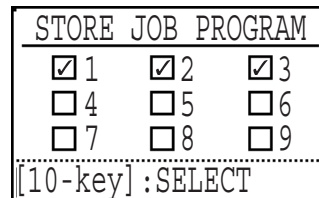
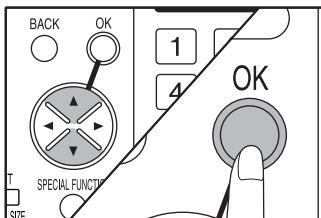

- To cancel the job memory mode, press the BACK key or the CLEAR ALL (CA) key.

4 Select a program number from 1 to 9 using the numeric keys.

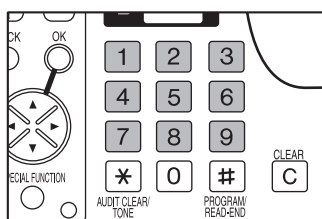

- A screen indicating that the settings have been stored will appear and then the display will return to the basic screen.
- The numbers with a check mark are program numbers which already contain job programs. If a program number containing a job program is entered, the message "Storage number selected is already used. Replace it?" will appear to confirm the selection. To replace an existing program with the new program, select "YES" with the ▲ and ▼ keys and press the OK key.
- If the existing program is not to be replaced, select "NO" with the ▲ and ▼ keys, press the OK key, and select another register number.

Deleting a job program

1 Press the PROGRAM key.

- The JOB PROGRAMS screen will appear.

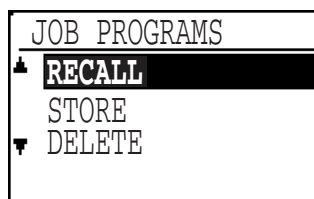
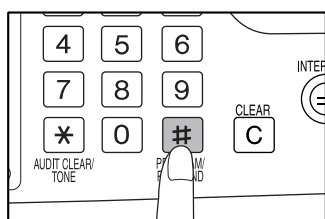

2 Use the ▲ and ▼ keys to select "DELETE" and press the OK key.

- The DELETE JOB PROGRAM screen will appear.

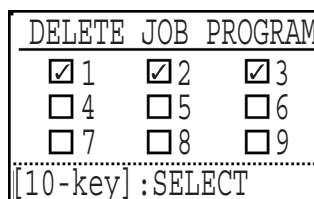
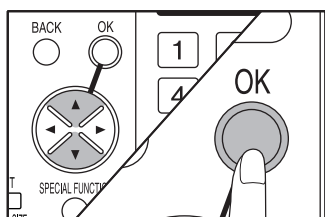

- To cancel the job memory mode, press the BACK key or the CLEAR ALL (CA) key.

3 Select a program number from 1 to 9 using the numeric keys.

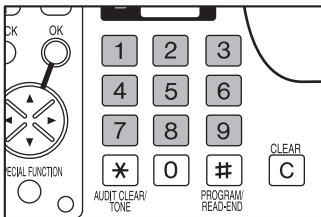

- The numbers with a check mark are program numbers which contain job programs. If a checked number is entered, the message "Delete job program?" will appear to confirm the selection to delete the program. To delete the program, select "YES" with the ▲ and ▼ keys and press the OK key.
- If "NO" is selected, the previous screen will reappear.

Recalling a job program

1 Press the PROGRAM key.

- The JOB PROGRAMS screen will appear with RECALL highlighted.

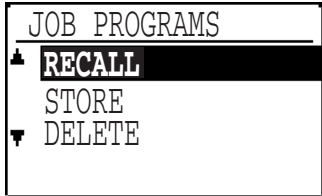
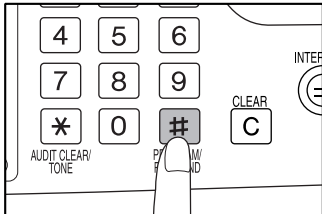

2 Press the OK key.

- The RECALL JOB PROGRAM screen will appear.

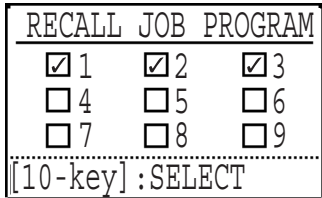
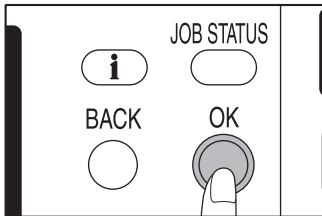

SPECIAL FUNCTIONS

3 Select a program number from 1 to 9 using the numeric keys.

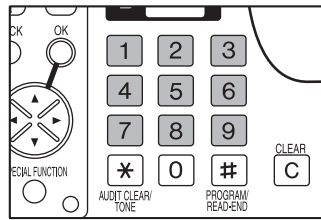

- The numbers with a check mark are program numbers which contain job programs. If a checked number is entered, the settings for that job program will be recalled and the display will return to the basic screen.
- The recalled settings may be modified for a particular job run, but any changes made will not be stored in the job memory. To store the new settings, follow the "Storing a job program" procedure.



CHAPTER 4











COPIER TROUBLE?

This chapter describes how to remove misfed paper and how to remedy minor problems.

	Page
● STATUS MESSAGES	72
● MISFEED REMOVAL	73
Misfeed in the RSPF	73
Misfeed in the bypass tray	75
Misfeed in the copier	76
Misfeed in the center tray	79
Misfeed in the upper paper tray	80
Misfeed in the lower paper tray	80
Misfeed in the upper exit area	81
● TROUBLESHOOTING	83

STATUS MESSAGES

If any of the following messages appears in the display, carry out the prescribed remedy.

Message	Remedy
 (Maintenance icon) ⓘ -----  Maintenance required soon.	Service by an authorized SHARP service technician will be required soon. Contact your service center as soon as possible. (This message will be displayed if the information key is pressed when the information (ⓘ) icon is displayed.)
 Maintenance required. Call for service.	Normal maintenance service by an authorized SHARP service technician is needed. Contact your service center.
 Call for service. ****	A malfunction has occurred which cannot be corrected by the key operator. Contact your authorized SHARP service center for service.
 (Toner cartridge replacement required icon) ⓘ -----  Toner is low.	Replacement of the toner cartridge will be needed soon. (This message will be displayed if the information key is pressed when the information (ⓘ) icon is displayed.) See page 90.
 Check the toner cartridge.	Check to see if the toner cartridge has been installed properly.
Can not continue.  Remove paper from the center tray.	The number of copies on the center tray has reached the limit. Remove the copies from the center tray.
Please check paper in paper tray<*>.	Check to see if copy paper has been loaded properly.
 Load <*> paper into tray <*>. Or cancel job and change the paper size setting.	The paper size specified for the tray is different from the actual size. See page 86.
Selected paper tray is out of service.	Contact your authorized SHARP service center for service.
Check stapler or staple jam.	Staples become jammed or the staple box is not installed properly (when an optional finisher is installed). Check the staple box. See page 108 for staple jam removal. Contact your authorized SHARP service center for service.
 Please remove paper from the stapler compiler.	Paper is left in the stapler compiler. Remove it. See page 110.

<*>: paper tray number
 <*>: paper size to be set

MISFEED REMOVAL

When a misfeed occurs, the copier will stop. The message "Clear paper path." will appear in the display along with an illustration showing paper misfeed locations.

- If paper becomes accidentally torn during removal, be sure to remove all pieces. Be careful not to damage the photoconductive drum.
- For misfeeds in optional equipment, see their respective sections of the operation manual.
- ★ **KEY OPERATOR** If the backlight change of the display is enabled using a key operator program, the color of the backlighting will change to orange when a misfeed occurs. See page 16 of the KEY OPERATOR'S GUIDE.

First confirm the misfeed locations.

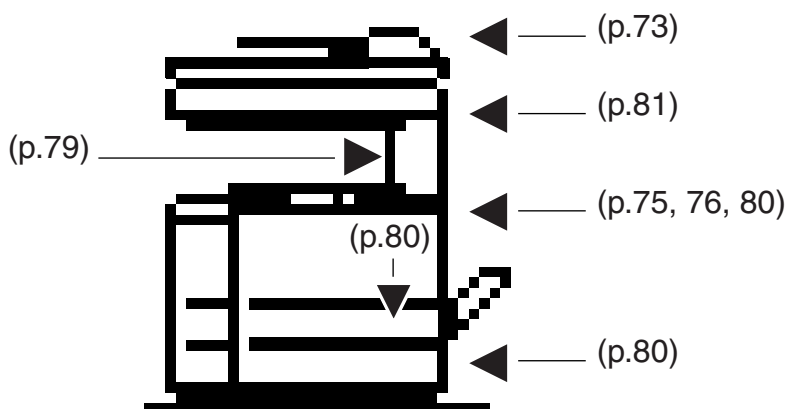

Misfeed in the RSPF

If an original misfeed occurs in the RSPF, the copier will stop and the message "Clear paper path." will appear.

1 Remove the misfed originals.

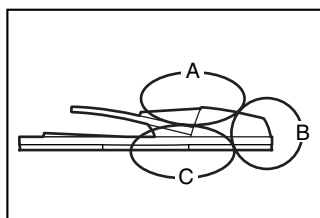

Location A

- Open the feeding roller cover and pull the misfed original gently to the left and out from the document feeder tray. Close the feeding roller cover.

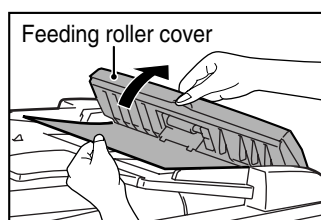

MISFEED REMOVAL

Location B

- Open the document feeder cover, rotate the rollers in the direction indicated by the arrow to feed the misfed paper, and then gently remove the misfed original after closing the document feeder cover.

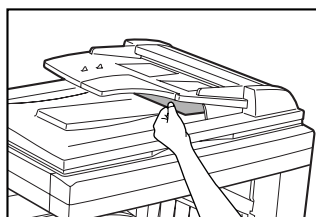
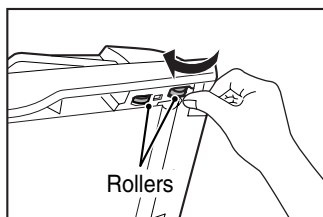

- If a small original such as 5-1/2" x 8-1/2" original has misfed or an original has misfed in the reversing tray, open the right side cover and gently remove the misfed original. Close the right side cover.

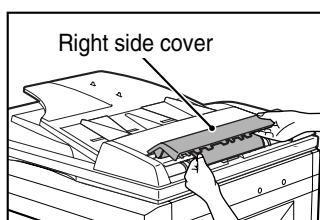

Location C

- Gently remove the misfed original from the exit area.

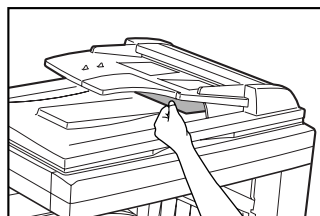

- If the misfed original cannot be easily removed from the exit area, open the front part of the document feeder tray to remove the original. With the RSPF, pull out the reversing tray to remove the misfed original.

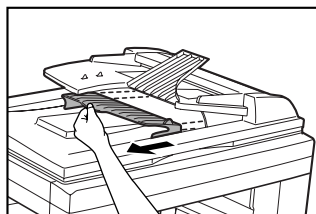
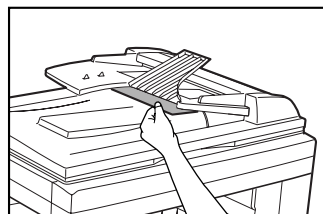

NOTE:

With the RSPF, after removing the misfed original from the exit area, be sure to insert the reversing tray into the exit area until it locks in place.

2 Open and close the document feeder cover to cancel the misfeed display.

- You can also cancel the misfeed display by opening and closing the feeding roller cover or the right side cover.
- The number of originals that must be returned to the document feeder tray will be indicated in the display.

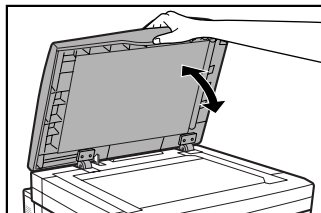

3 Return the indicated number of originals to the document feeder tray and press the START (⏏) key to resume copying.

Misfeed in the bypass tray

1 Gently pull the misfed paper out from the bypass tray.

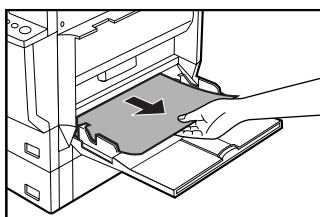

2 Open and close the side cover to cancel the misfeed display.

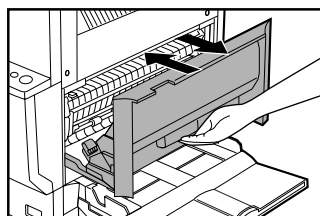

- You can also cancel the misfeed display by opening and closing the front cover.
- Confirm that the misfeed display has been cleared. If the misfeed display is not cleared, remove the misfed paper referring to "A. Misfeed in the paper feed area".

Misfeed in the copier

Check the misfeed location. Remove the misfed paper following the instructions for each location in the illustration below.

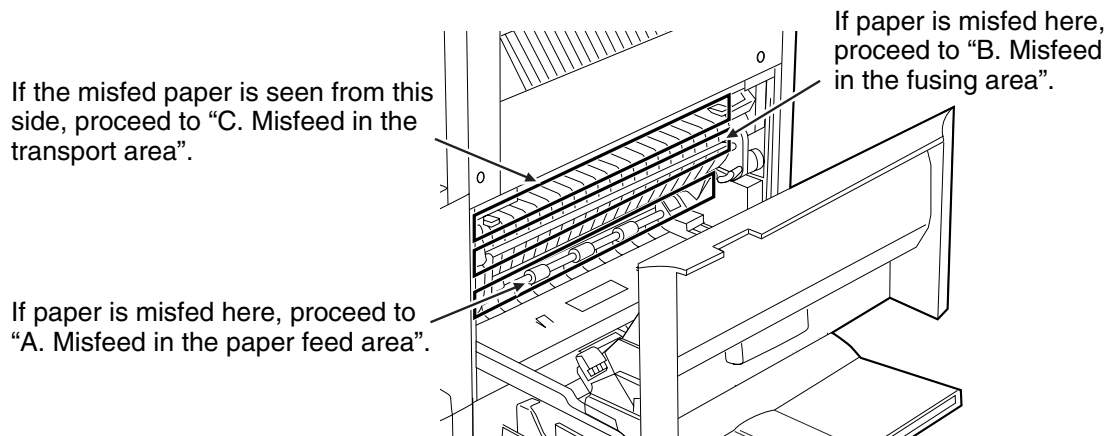

A. Misfeed in the paper feed area

- 1 Open the bypass tray and the side cover.

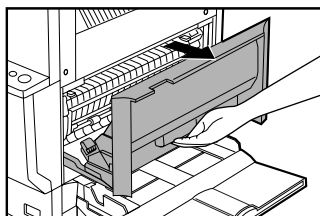

- 2 Gently open the front cover.

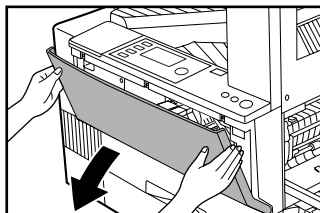

- 3** Carefully remove the misfed paper. Turn the roller rotating knob in the direction of the arrow to assist in removing it.

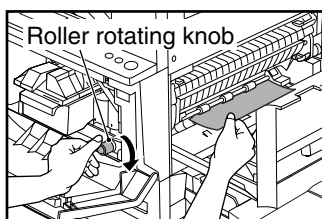

WARNING:
The fusing unit is hot. Take care in removing paper.



CAUTION:
Do not touch the photoconductive drum (green portion) when removing the misfed paper. Doing so may damage the drum and cause smudges on copies.

- 4** Close the front cover and the side cover.

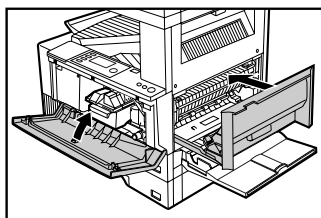

- Confirm that the misfeed display has been cleared.

B. Misfeed in the fusing area

- 1** Open the bypass tray and the side cover.

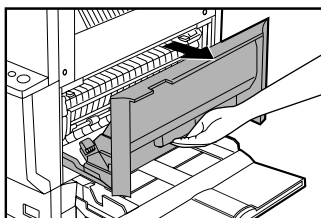

- 2** Gently open the front cover.

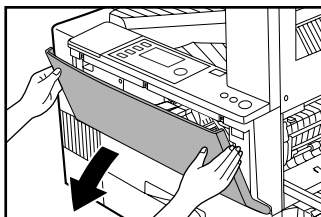

MISFEED REMOVAL

- 3** Turn the roller rotating knob in the direction of the arrow.

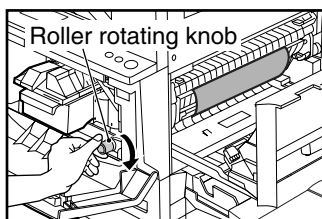

- 4** Carefully remove the misfed paper. Lower the fusing unit release levers to allow easier removal. After removal, return the release levers to their operating positions.

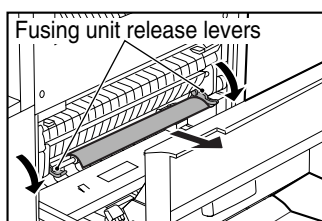

WARNING:

The fusing unit is hot. Take care in removing paper.



CAUTION:

- Do not touch the photoconductive drum (green portion) when removing the misfed paper. Doing so may damage the drum and cause smudges on copies.
- Be careful, there may be unfused toner on the misfed paper which could soil your hands or clothes.

- 5** Close the front cover and the side cover.

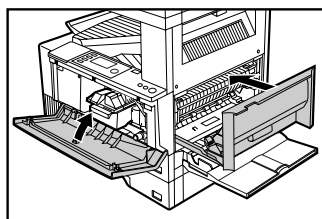

- Confirm that the misfeed display has been cleared.

C. Misfeed in the transport area

- 1 Open the bypass tray and the side cover.

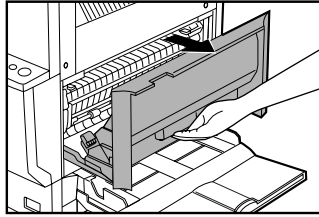

- 2 Use the green tabs on either side of the paper guide to rotate the guide open and remove the misfed paper.

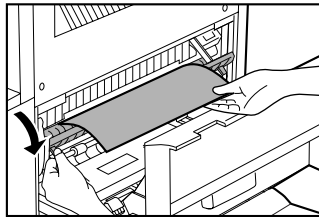

WARNING:
The fusing unit is hot. Take care in removing paper.

- 3 Close the side cover.
 - Confirm that the misfeed display has been cleared.

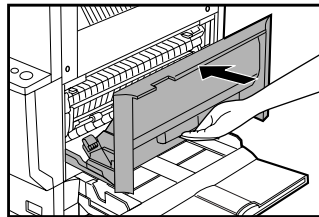

Misfeed in the center tray

- 1 Remove the paper by pulling it into the center tray.

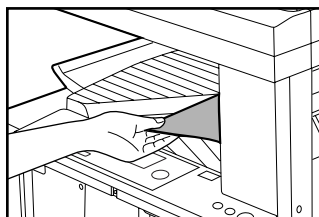

Misfeed in the upper paper tray

Before opening the upper paper tray, be sure to open the bypass tray and the side cover and then perform steps 1 to 3 described in the "A. Misfeed in the paper feed area" section.

- 1 Pull out the upper paper tray and remove the misfed paper.**

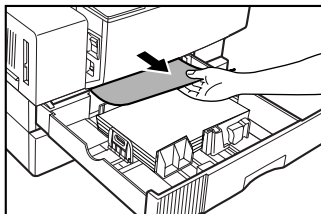

- 2 Close the paper tray.**

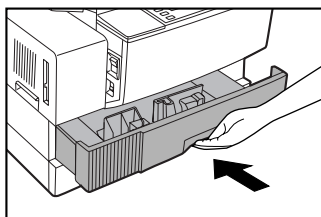

- 3 Open and close the side cover to cancel the misfeed display.**

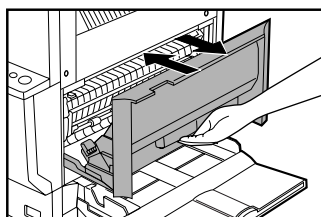

- You can also cancel the misfeed display by opening and closing the front cover.
- Confirm that the misfeed display has been cleared.

Misfeed in the lower paper tray

- 1 Grasp the handle of the lower side cover and gently open the cover.**

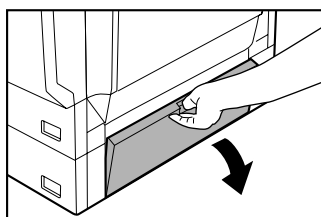

2 Remove the misfed paper.

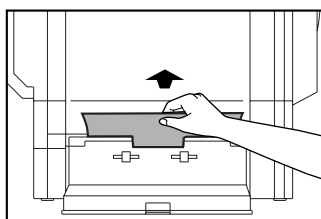

- Be careful not to tear the misfed paper during removal.

3 If the misfed paper is not seen in step 2, pull out the lower paper tray and remove the misfed paper.

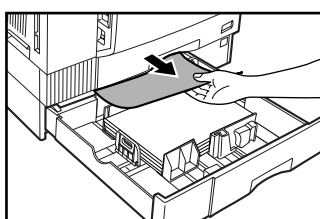

- Be careful not to tear the misfed paper during removal.

4 Close the paper tray.

5 Close the lower side cover.

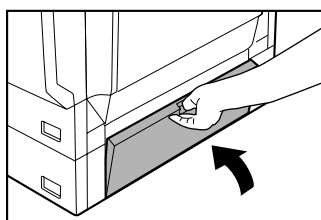

- Confirm that the misfeed display has been cleared.

Misfeed in the upper exit area

If an optional job separator tray kit or an optional finisher is installed, a misfeed may occur in the upper exit area.

1 Open the upper exit area cover.

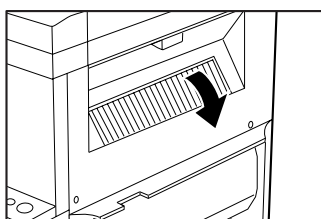

MISFEED REMOVAL

- 2 Gently pull the misfed paper out.**

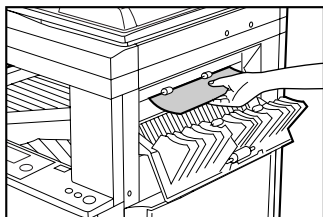

- 3 Close the upper exit area cover.**
 - Confirm that the misfeed display has been cleared.

TROUBLESHOOTING

Always check the message display whenever the copier stops during an operation or operation is not possible. Messages in the display will give you easy-to-follow directions. For other troubles not described by messages, check the chart below.

Problem	Solution	
Copier does not operate.	● Copier plugged in?	Plug the copier into a grounded outlet as specified. See page 97.
	● Power switch ON?	Turn the power switch ON. See page 16.
Copies are too dark or too light.	● Copy density properly adjusted?	Adjust the exposure. See page 34.
Blank copies	● Is the original placed face down?	Place the original face down on the platen glass.
The size of copies is different from the selected paper size. (Part of the original image is not copied. A blank space is copied.)	● Is the paper size specified for the tray different from the actual size?	The size of the paper must be entered. See page 88.
Copies smear if rubbed.	● Paper too heavy?	Use copy paper within the specified range. See page 86.
	● Paper damp?	Replace with dry copy paper. Be sure to store copy paper in a dry location. See page 96.
Paper misfeeds frequently.	● Non-standard paper used?	Use standard paper. If using special paper, feed the paper through the bypass tray. See pages 41 and 86.
	● Paper properly installed?	Make sure the paper is properly installed. See pages 41 and 86.
	● Pieces of paper inside copier?	Remove all pieces of misfed paper. See page 73.
	● Paper curled or damp?	Store copy paper flat in the wrapper in a dry location. See page 96.
Original size not selected automatically.	● Has the platen cover been completely opened when the original is placed on the platen glass?	Open the platen cover completely and then place the original on the platen glass. Close the platen cover.
	● Does the original include any large black solid areas?	If the original includes any large black solid areas, the original size may not be detected. Press the SPECIAL FUNCTION key and select "ORIG. SIZE ENTER" to specify the original size. See page 24.

TROUBLESHOOTING

Problem	Solution	
Copies are smudged or dirty.	● Platen glass or platen cover dirty?	Clean regularly. See page 93.
	● Original smudged or blotchy?	Use a clean original.
Black or white stripes appear on copies.	● Is the scanning window of a RSPF dirty?	Clean the scanning window.
Paper size for a paper tray cannot be set.	● Is the COPY indicator off?	Press the COPY key to select the COPY mode. See page 14.
	● Is copying, printing or facsimile printing being performed?	Set the paper size after copying, printing or facsimile printing is complete.
Power is on but copying is not possible.	● Are only the mode indicators on?	The copier is in the auto power shut-off mode. Press the COPY key or another mode key that is lit.
	● Is the COPY indicator off?	Press the COPY key to select the COPY mode.
	● Is two-sided printing being performed?	Wait until the printing job finishes.
Lighting fixture flickers.	● Is the same power outlet used for the lighting fixture and the copier?	Connect the copier to a power outlet which is not used for other electric appliances.



CAUTION:

Be sure to use only genuine SHARP parts and supplies.

Please contact your SHARP service center immediately if a problem persists after checking the above.

CHAPTER 5

GENERAL INFORMATION

This chapter describes general information about the use of the copier and the loading of paper and toner.

	Page
● PAPER	86
Types and sizes of copy paper	86
Loading copy paper	86
Changing the copy paper size in the tray	88
● TONER CARTRIDGE REPLACEMENT	90
● CHECKING THE TONER QUANTITY AND TOTAL OUTPUT COUNT	92
● CLEANING THE PLATEN GLASS AND RSPF	93
● CLEANING THE BYPASS TRAY PAPER FEED ROLLER	94
● DISPLAY CONTRAST ADJUSTMENT	95
● STORAGE OF SUPPLIES	96
Proper storage	96
● SPECIFICATIONS	97

PAPER

Types and sizes of copy paper

Types and sizes of copy paper which can be fed from the paper trays are shown below. For paper acceptable for feeding from the bypass tray, see page 41.

Size	Weight	Capacity (21 lb. bond paper)
5-1/2" x 8-1/2" to 11" x 17" A5 to A3	15 lbs. to 21 lbs.	500 sheets

- 5-1/2" x 8-1/2" and A5 copy papers cannot be fed from any tray except the uppermost tray. (including trays in optional paper feed units)
- B5 paper cannot be set for paper tray 2.
- Special papers including transparency film must be fed through the bypass tray.

Loading copy paper

To save space, this copier has been designed with adjustable front-loading trays, which are easily opened for paper loading. For best results, use only SHARP recommended paper. The message "TRAY<*>: Add paper." will be displayed when there is no copy paper in the selected paper feed station.

When the selected paper tray is not installed or is improperly installed, "Close paper tray <*>." will be displayed. Install it or push it back firmly into place.

NOTE:

When the paper size is changed in a paper tray, the size of the paper must be entered as described on page 88. If not, the machine will stop copying and the message "Load <***> paper into tray <*>. Or cancel job and change the paper size setting." will appear in the display. In this case, load the paper requested in the message or enter the paper size that is already installed in the paper tray.

<*> : paper tray number

<***>: paper size to be set

1 Pull out the paper tray until it stops.

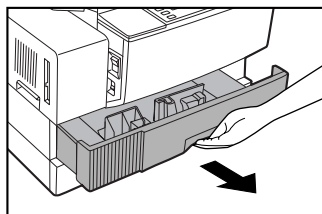

2 Squeeze the lock lever of the front guide and slide the front guide to match the width of the paper.

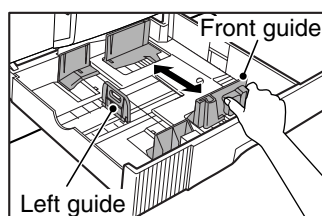

3 Move the left guide to the appropriate slot as marked on the tray.

- When using 11" x 17" copy paper, store the left guide in the slot at the left front of the paper tray.

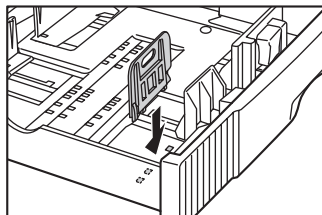

4 Fan the copy paper and insert it into the tray.

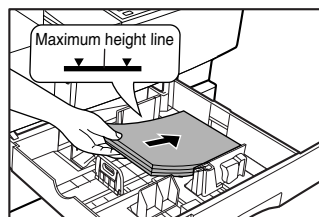
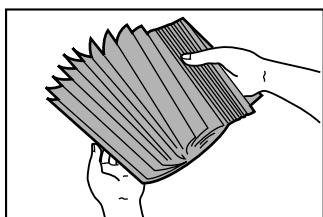

- Set the paper along the guides.
- The tray holds up to 500 sheets of 21 lb. bond paper.
- Do not load paper above the maximum height line.

5 Push the paper tray firmly back into the copier.

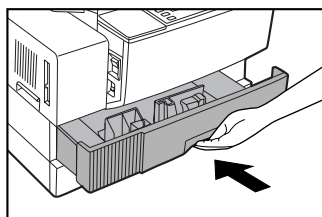

- If the paper size is changed in steps 3 and 4, place the paper size card in the front of the paper tray to indicate the selected paper size. Proceed to the next section.

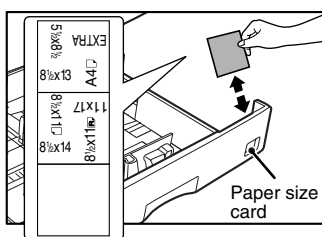
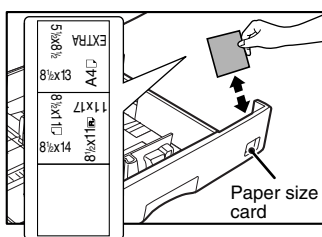

Changing the copy paper size in the tray

Paper size setting can only be done while the machine is not operating and the COPY mode has been selected.

- B5 paper cannot be set for paper tray 2.

1 Press the SPECIAL FUNCTION key.

- The SPECIAL FUNCTION screen will appear.

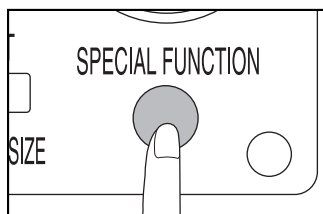

2 Use the ▲ and ▼ keys to select "PAPER SIZE SET" and press the OK key.

- The paper size setting screen will appear.

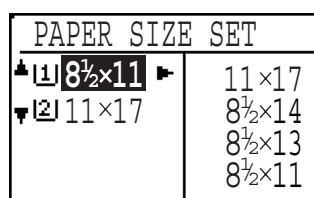
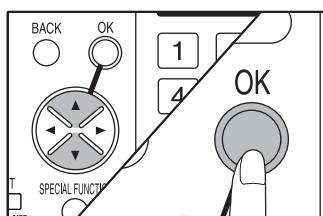

3 Use the ▲ and ▼ keys to select the paper tray for which the paper size is being changed.

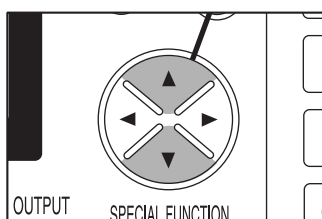

4 Press the ► key.

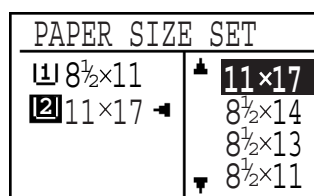
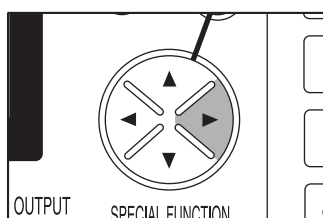

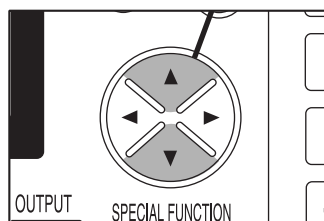
5 Use the ▲ and ▼ keys to select the paper size that has been set.

- To change the size of another paper tray, press the ◀ key and then repeat steps 3 to 5.

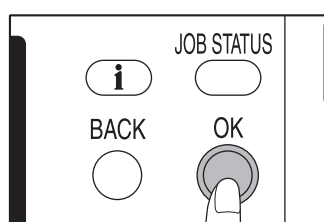
6 Press the OK key.

- A confirmation message for paper size setting will appear.

7 Press the OK key.

- The specified paper size will be registered and the display will return to the basic screen.

TONER CARTRIDGE REPLACEMENT

The approximate quantity of toner remaining can be displayed by pressing and holding the COPY key during standby or warm-up. See page 92. When the quantity of toner remaining is less than 25%, obtain a new cartridge. When the toner cartridge replacement required icon (:.) appears in the display, replacement of the toner cartridge will be needed soon. If you press the information key, the message "Toner is low." will appear in the display. When the message "Add toner. Can not copy or print." appears in the display, the toner cartridge must be replaced before copying can be resumed. Replace the toner cartridge by following the procedure below.

★**KEY OPERATOR** If the backlight change of the display is enabled using a key operator program, the color of the backlighting will change to yellow when the message "Toner is low." appears and will change to orange when the message "Add toner. Can not copy or print." appears. See page 16 of the KEY OPERATOR'S GUIDE.

NOTE:

During a long copy run of a dark original, the message "Toner replenishment in progress." may appear and the copier will stop, even though toner is left. The copier will feed toner for up to 2 minutes and then the START (⏏) key indicator will light up. Press the START (⏏) key to restart copying.

SHARP

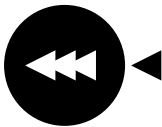

GENUINE SUPPLIES

For best copying results, be sure to use only SHARP Genuine Supplies which are designed, engineered and tested to maximize the life and performance of SHARP copiers. Look for the Genuine Supplies label on the toner package.

1 Gently open the front cover.

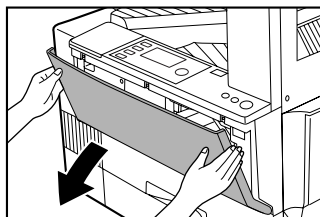

2 Push the toner cartridge lock release lever and pull the toner cartridge out. Remove the toner cartridge while supporting it with the left hand at the green label portion.

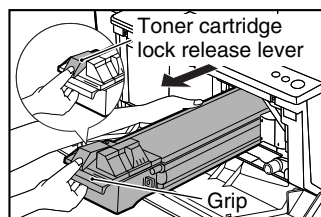

- For disposal of the old toner cartridge, contact your dealer.

NOTE:

After removing the toner cartridge, do not shake it or tap on it. Doing so may cause toner to leak from the cartridge. Put the old cartridge immediately in the bag contained in the box of the new cartridge.

- 3** Remove the new toner cartridge from the bag. Grasp the cartridge on both sides and shake it horizontally approximately 20 times. After shaking the cartridge, remove the tape.

NOTE:

Grasp the grip when holding the cartridge. Do not hold the cartridge by the shutter. Be sure to only shake the cartridge before the tape is removed.

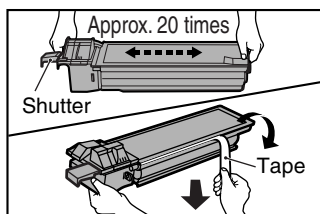

- 4** Gently insert the toner cartridge along the guides until it clicks in place while pushing the lock release lever.

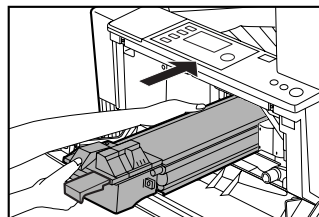
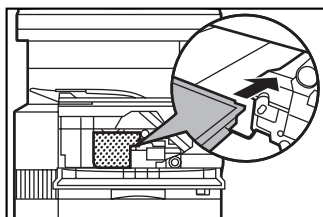

NOTE:

If dirt or dust is adhered to the toner cartridge, remove it before installing the cartridge.

- 5** Remove the tape from the shutter. Pull the shutter out of the toner cartridge as shown in the illustration. Discard the shutter.

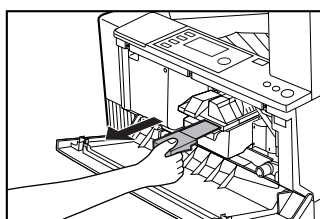

- 6** Close the front cover.

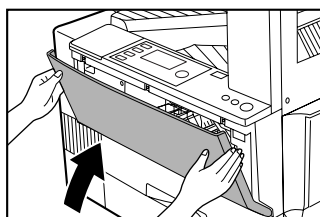

CHECKING THE TONER QUANTITY AND TOTAL OUTPUT COUNT

The approximate quantity of toner remaining and the total output count can be displayed by the procedure below. The total count value displayed is the output count in the copy, print, and fax modes including the output count by the self-print function of the printer and facsimile features.

1 Press and hold the COPY key during standby or warm-up.

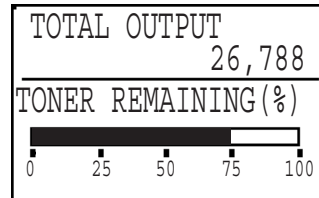
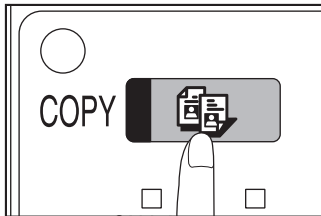

- The toner quantity and the total output count will be displayed in the display while the key is pressed.

NOTE:

An 11" x 17" or A3 sheet is counted as two sheets. A two-sided copy is also counted as two sheets.

About the toner indicator

The amount of toner remaining is indicated in 5 levels. Use this indicator as a guideline for replacement of the toner cartridge.

Refer to the table below for the relation between the indicator level and the amount of toner remaining.

- When the toner level falls below 25%, obtain a replacement toner cartridge as soon as possible.
- For more information, consult your dealer.

Toner level indicator	Amount of toner remaining (approximate)
TONER REMAINING (%) 	100% to 90%
TONER REMAINING (%) 	90% to 75%
TONER REMAINING (%) 	75% to 50%
TONER REMAINING (%) 	50% to 25%
TONER REMAINING (%) 	Less than 25% Obtain a replacement toner cartridge as soon as possible.

NOTE:

- The amount of toner used will vary depending on conditions of machine usage and the content of the documents printed. Use the above toner levels as a general guideline.

CLEANING THE PLATEN GLASS AND RSPF

Proper care is essential for clean, sharp copies. Please take a few minutes to regularly clean your copier.

Stains or dirt on the platen glass or RSPF will also be copied. Wipe the platen glass, platen cover portion of the RSPF and the scanning window on the platen glass with a soft, clean cloth.

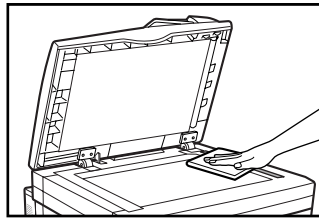
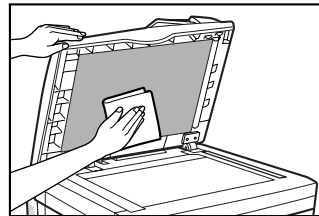
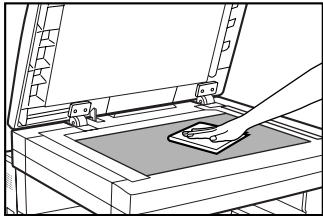

- If necessary, dampen the cloth with water. Do not use thinner, benzene, or similar volatile cleaning agents.

CLEANING THE BYPASS TRAY PAPER FEED ROLLER

If misfeeds occur frequently when feeding postcards, envelopes, thick paper, etc. through the bypass tray, wipe the paper feed roller at the feed slot of the bypass tray with a soft, clean cloth dampened with alcohol or water.

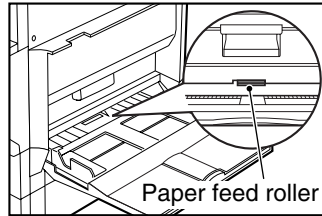

DISPLAY CONTRAST ADJUSTMENT

The contrast of the display can be adjusted as below.

1 Press the SPECIAL FUNCTION key.

- The SPECIAL FUNCTION screen will appear.

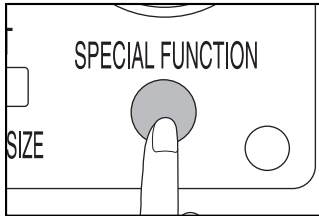

2 Use the ▲ and ▼ keys to select "DISPLAY CONTRAST" and press the OK key.

- The screen for contrast setting will appear.

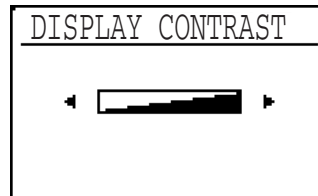
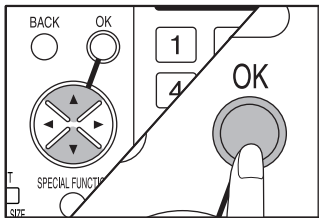

3 Use the ◀ and ▶ keys to adjust the contrast.

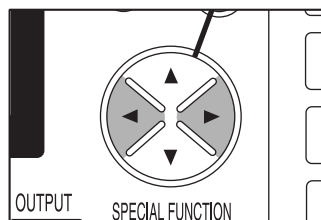

- To reset the contrast to the default setting, press the CLEAR (C) key.

4 Press the SPECIAL FUNCTION key.

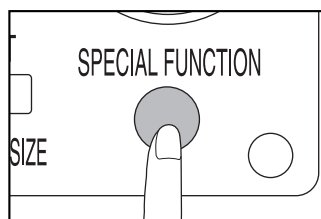

- The display will return to the basic screen.

STORAGE OF SUPPLIES

Standard supplies for this copier that are to be replaced by the user are copy paper, toner cartridge, and staple cartridge for the optional finisher (AR-FN5 N).

SHARP

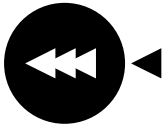

GENUINE SUPPLIES

For best copying results, be sure to use only SHARP Genuine Supplies which are designed, engineered, and tested to maximize the life and performance of SHARP copiers. Look for the Genuine Supplies label on the toner package.

Proper storage

1 Store the supplies in a location that is:

- clean and dry,
- at a stable temperature,
- not exposed to direct sunlight.

2 Store copy paper in the wrapper and lying flat.

- Paper stored in packages standing up or out of the wrapper may curl or become damp, resulting in paper misfeeds.

SPECIFICATIONS

Type	Desktop
Copy system	Dry, electrostatic transfer
Originals	Sheets, bound documents
Original sizes	Max. 11" x 17"
Copy sizes	Max. 11" x 17", Min. 5-1/2" x 8-1/2" Image loss: Max. 5/32" (4 mm) (leading and trailing edges), Max. 1/8" (3 mm) (along other edges)
Copying speed (one-sided copying at 100% copy ratio)	600 dpi : 20 copies/min. (8-1/2" x 11") 00 copies/min. (8-1/2" x 11"R) 00 copies/min. (8-1/2" x 14") 00 copies/min. (11" x 17")
Continuous copy	Max. 999 copies; subtractive counter
First-copy time	4.8 seconds (except in a power save mode)*
Warm-up time	Approx. 40 seconds
Copy ratio	Variable: 25% to 400%, in 1% increments (total 376 steps) Fixed preset: 25%, 50%, 64%, 77%, 95%, 100%, 121%, 129%, 141%, 200%, 400% When the RSPF is being used, the copy ratio range is limited within 50% to 200%.
Exposure system	Moving optical source, slit exposure (stationary platen) with automatic exposure function
Copy paper feed	Two paper trays with automatic feed (500 sheets each), one bypass tray with automatic feed (100 sheets)
Fusing system	Heat rollers
Developer system	Magnetic brush development
Light source	Xenon lamp
Resolution	Scan: 400 dpi Output: 600 dpi
Gradation	Scan: 256 levels Output: 2 levels
Power supply	AC 120 - 127V, 60 Hz, 10 amperes
Power consumption	Max. 1.2 kW
Overall dimensions (with bypass tray folded)	24-13/16" (W) x 23-3/64" (D)(628 mm (W) x 585.5 mm (D))
Weight	Approx. 105.2 lbs. (47.8 kg), toner cartridge included
Copier dimensions	24-13/16" (W) x 23-3/64" (D) x 30-23/64" (H) (628 mm (W) x 585.5 mm (D) x 771 mm (H))
Operating conditions	Temperature: 59°F to 86°F (15°C to 30°C) Humidity: 20% to 85%

SPECIFICATIONS

Noise level	Sound Power Level L _{WA} Copying: 6.3 [B], Standby: 3.9 [B] Sound Pressure Level L _{PA} (bystander positions) Copying: 49 [dB (A)], Standby: 24 [dB (A)] Noise emission measurement in accordance with ISO 7779.
Emission concentration (measurement according to RAL-UZ 62)	Ozone: 0.02 mg/m ³ or less Dust: 0.075 mg/m ³ or less Styrene: 0.07 mg/m ³ or less
Optional equipment	Finisher (AR-FN5 N) 500-sheet paper feed unit (AR-D11) 2x500-sheet paper feed unit (AR-D12) Printer expansion kit (AR-P11) PS3 expansion kit (AR-PK1) Barcode font kit (AR-PF1) Job separator tray kit (AR-TR3) Print server card (AR-NC5J) Facsimile expansion kit (AR-FX4) Network scanner expansion kit (AR-NS2)

*First-copy time may differ depending on operating conditions, such as power-supply voltage and room temperature.

Printer specifications

Printing speed	20 pages/min.
Resolution	600 dpi
IMC Memory	16MB
Additional memory	Expandable to 272MB by adding 32MB, 64MB or 128MB memory modules (168 pin SDRAM DIMM) in the two expansion DIMM slots.
Interface	IEEE 1284-compliant bi-directional parallel interface/USB interface (USB1.1 Standard)
Interface cable	USB cable: Shielded twisted pair cable (3m (10 ft.) Max.: high-speed transmission equivalent) Parallel interface cable: IEEE 1284 - Shielded type bi-directional parallel interface cable (3m (10 ft.) Max.)

Reversing single pass feeder (RSPF) specifications

Acceptable originals	Weight	15 to 23 lbs.
	Size	5-1/2" x 8-1/2"* to 11" x 17" * 5-1/2" x 8-1/2" size originals cannot be used in the 2-sided copy mode.
	Capacity	Up to 40 sheets provided the total aggregate thickness does not exceed 5/32"
Power supply	Drawn from the copier	
Detectable original sizes	5-1/2" x 8-1/2", 8-1/2" x 11", 8-1/2" x 11"R, 8-1/2" x 14", 11" x 17"	

NOTE:

As a part of our policy of continuous improvement, SHARP reserves the right to make design and specification changes for product improvement without prior notice. The performance specification figures indicated are nominal values of production units and there may be some deviations from these values in individual units.

CHAPTER 6

OPTIONAL EQUIPMENT

This chapter describes operating instructions for the Single Pass Feeder (AR-SP4), the Reversing Single Pass Feeder (AR-RP3), the Finisher (AR-FN5 N), the 500-Sheet Paper Feed Unit (AR-D11), and the 2 x 500-Sheet Paper Feed Unit (AR-D12).

	Page
● SYSTEM CONFIGURATION	100
● FINISHER (AR-FN5 N)	101
Part names	101
Specifications	102
Supplies	102
Finisher functions	103
Staple sort.	104
Staple cartridge replacement	107
Staple jam removal	108
Misfeed removal	110
● 500-SHEET PAPER FEED UNIT (AR-D11)/ 2x500-SHEET PAPER FEED UNIT (AR-D12)	112
Part names.	112
Specifications	112
Loading copy paper	113
Changing the copy paper size in the tray	113
Misfeed removal	113

SYSTEM CONFIGURATION

A number of options are available for the copier which allow you to configure a copier system to meet your particular needs. The options include the following.

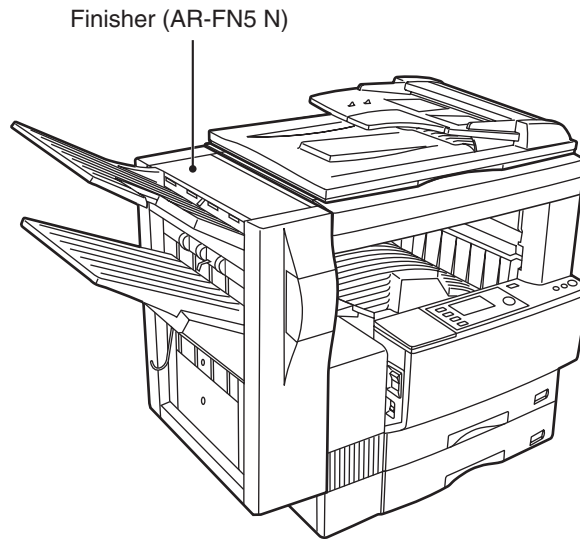

500-sheet paper feed unit (AR-D11)

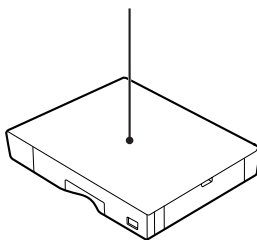

2x500-sheet paper feed unit (AR-D12)

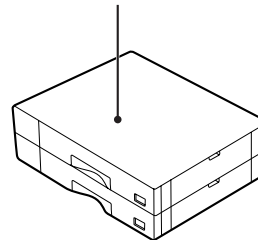

Printer expansion kit (AR-P11)
PS3 expansion kit (AR-PK1)
Barcode font kit (AR-PF1)
Job separator tray kit (AR-TR3)
Print server card (AR-NC5J)
Facsimile expansion kit (AR-FX4)
Network scanner expansion kit (AR-NS2)

FINISHER (AR-FN5 N)

The copier has two different finisher modes: one sorts copies into sets matching the sequence of the originals and the second groups copies by original. When an optional finisher (AR-FN5 N) is installed, the copier can automatically staple the sorted copies. Each collated set of copies or group of copies can be stacked offset from the previous set.

Part names

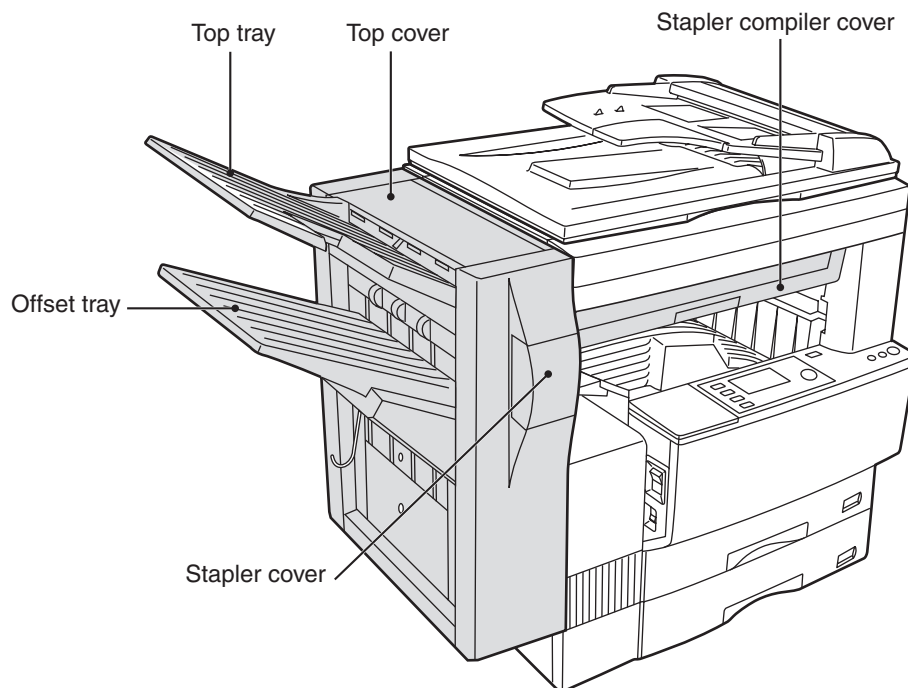

Specifications

Tray capacity	Top tray: 100 sheets
	Offset tray: 1,000 sheets (500 sheets for sizes larger than 8-1/2" x 11")
Paper size	Top tray: 5-1/2" x 8-1/2" to 11" x 17"
	Offset tray: 8-1/2" x 11" to 11" x 17"
Paper weight	Top tray: 15 lbs. to 21 lbs.
	Offset tray: 15 lbs. to 21 lbs.
Offset	Approx. 1 inch
Paper sizes that can be stapled	8-1/2" x 11", 8-1/2" x 11"R, 8-1/2" x 13", 8-1/2" x 14", 11" x 17"
Stapling capacity	30 sheets (20 lbs.)
Power supply	Drawn from the copier
Weight	Approx. 42 lbs. (19 kg)
Dimensions	Exit area: 18-33/64"(W) x 20-1/8"(D) x 21-17/64"(H) (470 mm (W) x 511 mm (D) x 540 mm (H))
	Stapler compiler: 22-11/64" (W) x 17-17/32" (D) x 4-17/64" (H) (563 mm (W) x 445 mm (D) x 108 mm (H))

NOTE:

As a part of our policy of continuous improvement, SHARP reserves the right to make design and specification changes for product improvement without prior notice. The performance specification figures indicated are nominal values of production units and there may be some deviations from these values in individual units.

Supplies

AR-SC1 staple cartridges must be used in this finisher. Staple cartridges are available from your SHARP dealer.

Finisher functions

When the finisher is installed, the following four output modes can be selected: sort, staple sort, group, and non-sort.

Press the OUTPUT key, use the ▲ and ▼ keys (or the OUTPUT key) to select the desired output mode, and then press the OK key. When copying in the sort or group mode, the output tray can be selected using the ◀ and ▶ keys and pressing the OK key.

- When a RSPF is used for copying, the sort mode will be selected as the default setting. When the platen glass is used for copying, the non-sort mode will be selected as the default setting.

Sort mode

Each set of copies will be sequentially delivered. Each collated set of copies will be stacked offset from the previous set unless the offset stack function is disabled.

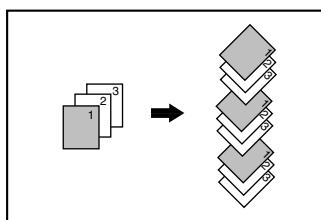

Group mode

All copies of the same original will be grouped. Copies will be offset and stacked in groups of multiple copies from the same original unless the offset stack function is disabled.

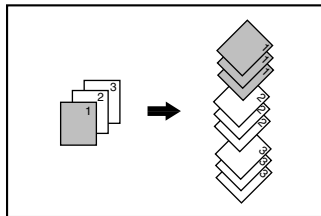

Staple sort mode

Collated sets of copies will be stapled and delivered to the offset tray but will not be offset.

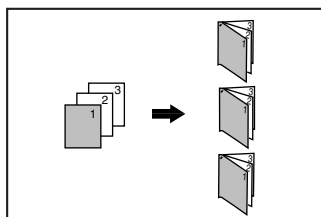

- See the next page for details.
- The bypass tray cannot be used in the staple sort mode.

Non-sort mode

All copies will be delivered without any of the finishing described above and without being offset.

Staple sort

In the staple sort mode, 8-1/2" x 11", 8-1/2" x 11"R, 8-1/2" x 13", 8-1/2" x 14", and 11" x 17" (B5, A4, A4R, B4, and A3) size copies can be stapled.

NOTE:

Different size originals cannot be copied onto copy paper of their respective sizes in the staple sort mode.

Using the RSPF

1 Set the originals in the document feeder tray.

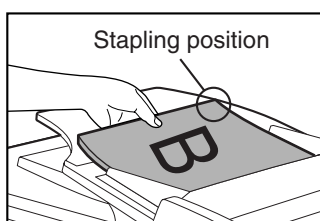

- If the number of copies in one set is more than 30, the copies will not be stapled.
- If the orientation of the originals does not match that of the copy paper, the images of the originals will be rotated. The stapling position varies with the orientation of the original.
- When copying 8-1/2" x 14" or 11" x 17" size originals with portrait orientation images, copies will be stapled at the position shown below.

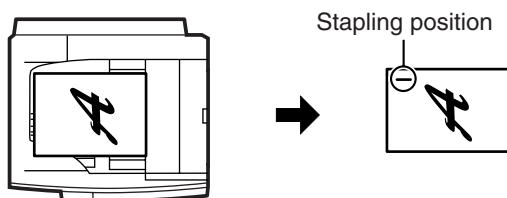

2 Press the OUTPUT key.

- The output mode selection screen will appear.

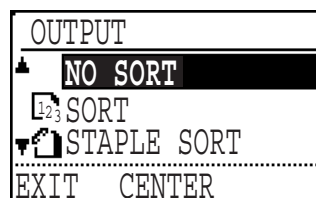
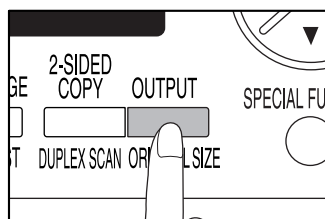

3 Use the ▲ and ▼ keys to select "STAPLE SORT" and press the OK key.

- Also the OUTPUT key can be used to select an output mode.

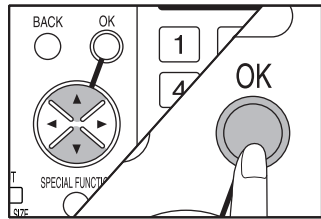

4 Set the number of copies and press the START (◀▶) key.

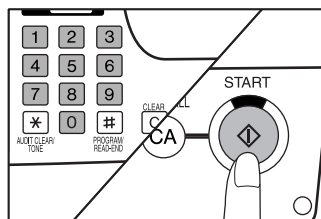

- When copying of a set is completed, the copies will be automatically stapled and delivered to the offset tray.

Using the platen glass

1 Set an original face down on the platen glass with the corner to be stapled to the upper right position.

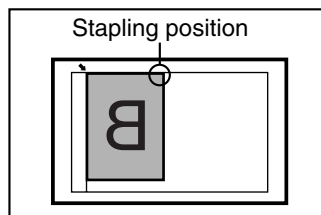

- If the number of copies in one set is more than 30, the copies will not be stapled.
- If the orientation of the original does not match that of the copy paper, the image of the original will be rotated. The stapling position varies with the orientation of the original.
- When copying 8-1/2" x 14" or 11" x 17" size originals with portrait orientation images, copies will be stapled at the position shown below.

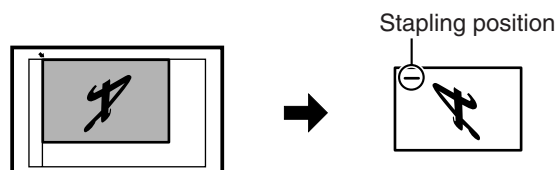

2 Press the OUTPUT key.

- The output mode selection screen will appear.

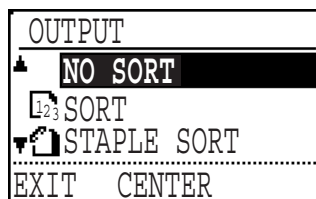
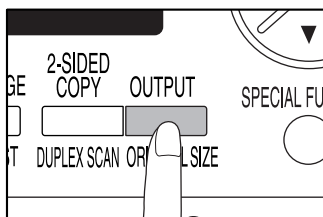

3 Use the ▲ and ▼ keys to select "STAPLE SORT" and press the OK key.

- Also the OUTPUT key can be used to select an output mode.

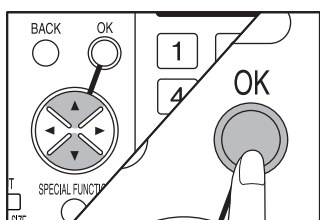

4 Set the number of copies and press the START (◊) key.

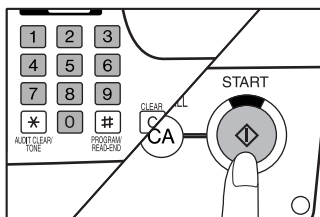

5 Replace the scanned original with the next original and press the START (◊) key after it lights up. Repeat this step until all originals have been scanned.

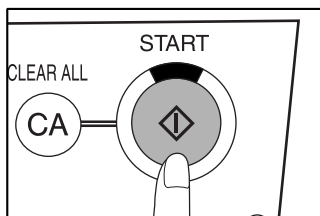

6 After all originals have been scanned, press the READ-END key.

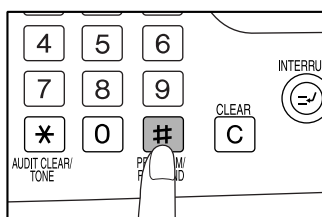

- Copying will start and each set of completed copies will be automatically stapled and delivered to the offset tray.
- If the message "Can not continue. Remove paper from the offset tray." appears in the display, remove the copies from the offset tray.

Staple cartridge replacement

When the message "Add staples." appears, replace the staple cartridge as follows:

1 Open the stapler cover.

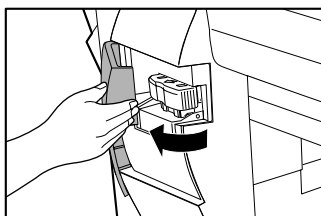

2 Grasp the green portion of the staple box and remove the staple box from the stapler.

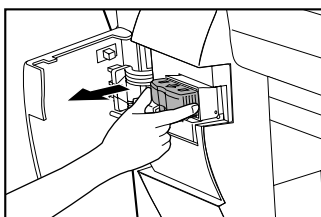

3 Remove the staple cartridge from inside the staple box.

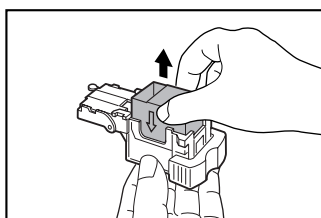

4 Insert the new staple cartridge into the box until it clicks into place.

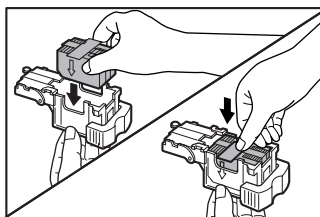

- Insert the new cartridge by aligning the arrows on the cartridge with those on the box. Check that the cartridge locks in place by pulling it slightly.
- A cartridge holds 3,000 staples.

5 Remove the tape from the cartridge.

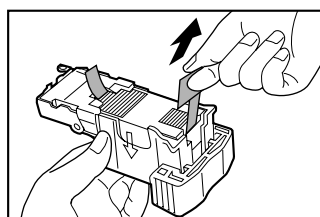

6 Insert the staple box into the stapler unit until it clicks into place.

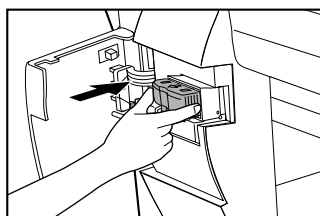

7 Close the stapler cover.

Staple jam removal

If staples become jammed in the stapler, the message "Check stapler or staple jam." will appear. Remove the jammed staples in the manner described below.

1 Open the stapler cover.

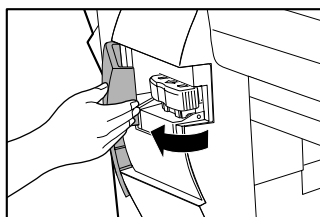

-
- 2** Grasp the green portion of the staple box and remove the staple box from the stapler.

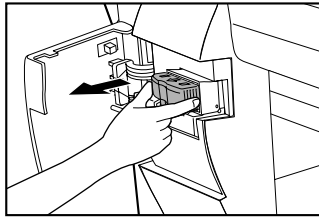

-
- 3** Raise the lever at the end of the staple box and remove the jammed staples.

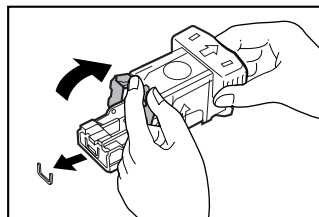

-
- 4** Return the lever to its original position.

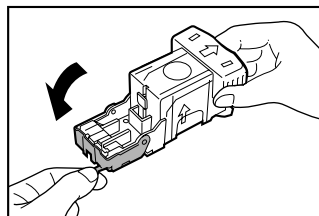

-
- 5** Insert the staple box into the stapler unit until it clicks into place.

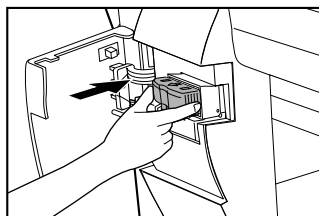

-
- 6** Close the stapler cover.

Misfeed removal

The copier will stop when a misfeed occurs. The message "Clear paper path." will appear along with a display of paper misfeed locations. When a misfeed is indicated for the finisher, follow the procedure below.

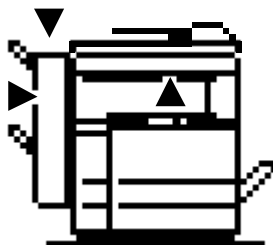

-
- 1** Pull the handle of the stapler compiler cover and open the cover.

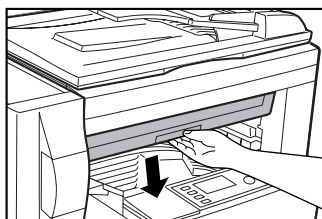

-
- 2** Remove any misfed paper from the transport area.

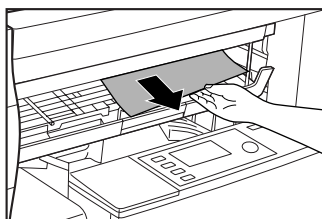

-
- 3** If staple sort copying is being done, open the paper guide and remove any misfed paper from the stapler compiler.

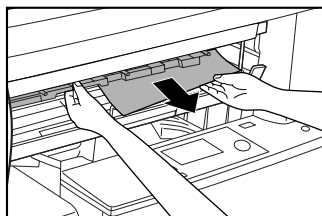

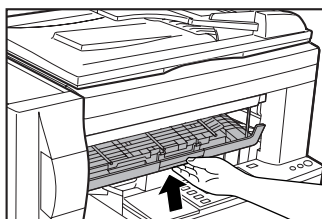
4 Close the stapler compiler cover.

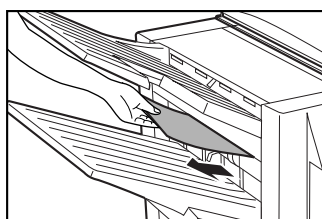
5 If the offset tray is being used, remove any misfed paper from the offset tray.

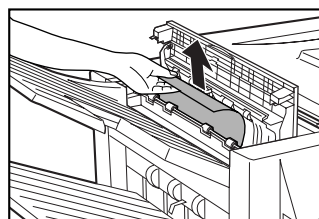
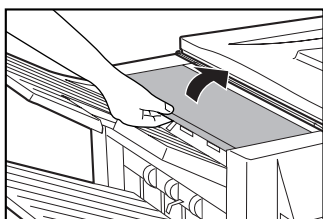
6 If the top tray is being used, open the top cover, remove any misfed paper, and close the top cover.

- Confirm that the misfeed display has been cleared.

500-SHEET PAPER FEED UNIT (AR-D11)/2x500-SHEET PAPER FEED UNIT (AR-D12)

These paper feed units provide the convenience of increased paper capacity for the copier and a greater choice of paper sizes readily available for copying. The AR-D11 contains one 500-sheet paper tray and the AR-D12 contains two 500-sheet paper trays.

Part names

AR-D11

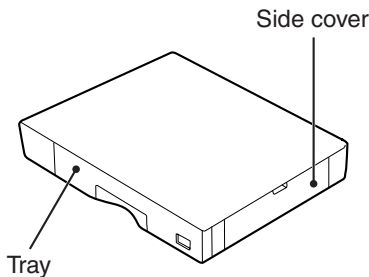

AR-D12

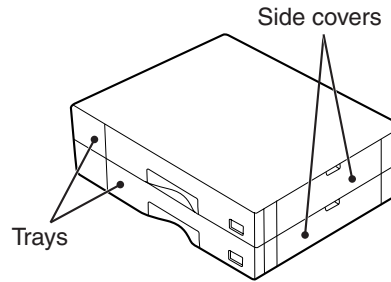

Specifications

	AR-D11	AR-D12
Copy paper size	8-1/2" x 11" to 11" x 17"	
Paper weight	15 lbs. to 21 lbs.	
Paper capacity	One paper tray with capacity for 500 sheets of 21 lb. bond paper	Two paper trays with capacity for 500 sheets of 21 lb. bond paper each
Weight	Approx. 13.5 lbs. (6.1 kg)	Approx. 26.1 lbs. (11.8 kg)
Dimensions	23-15/32" (W) x 18-35/64" (D) x 3-53/64" (H) (596 mm (W) x 471 mm (D) x 97 mm (H))	23-15/32" (W) x 18-35/64" (D) x 7-41/64" (H) (596 mm (W) x 471 mm (D) x 194 mm (H))
Power supply	Drawn from the copier	

NOTE:

As a part of our policy of continuous improvement, SHARP reserves the right to make design and specification changes for product improvement without prior notice. The performance specification figures indicated are nominal values of production units and there may be some deviations from these values in individual units.

- Two units of AR-D11 cannot be stacked for use with the copier.

Loading copy paper

The method of loading copy paper for these paper feed units is the same as for the paper trays in the copier. See page 86.

Changing the copy paper size in the tray

The method of changing the copy paper size is the same as for the paper trays in the copier. See page 88.

Misfeed removal

The copier will stop when a misfeed occurs. The message "Clear paper path." will appear along with a display of paper misfeed locations.

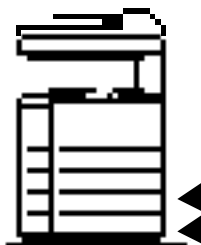

- 1 Open the side cover of the paper tray which was in use and remove the misfed paper.

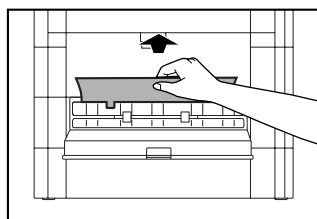
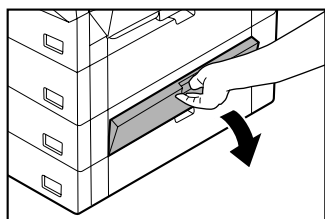

- Be sure to perform this step before pulling out the paper trays. If not, the paper may be torn as the trays are opened.

2 Pull out the paper tray which was in use.

3 Remove any misfed paper.

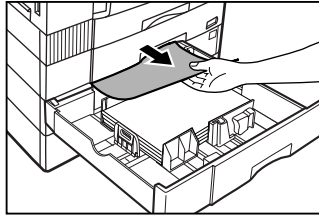

4 Close the paper tray.

5 Close the side cover.

- Confirm that the misfeed display has been cleared.

INDEX

2		
2 in 1	57	
2x500-sheet paper feed unit	112	
4		
4 in 1	57	
5		
500-sheet paper feed unit	112	
A		
Auditing accounts	20	
Auto clear	17	
Auto image	15, 36	
Automatic exposure adjustment	34	
Automatic reduction/enlargement	36	
Automatic two-sided copying	28	
Auto power shut-off mode	17	
B		
Basic screen	15	
B/W reverse	60	
Bypass tray	41	
C		
Cautions	7	
Center erase	53	
Center tray	12	
Changing copy paper size	88	
Copier installation	8	
Copier trouble?	71	
Copying		
– normal	24, 26	
– reduction/enlargement	36	
– through bypass tray	41	
– two-sided	28	
Copy paper	41, 86	
Copy quantity	25	
Copy ratio	36	
D		
Display	15	
Display contrast adjustment	95	
Dual page copy	55	
E		
Edge erase	53	
Enlargement	36	
Erase	53	
Exposure adjustment	34	
Exterior	12	
F		
Features	10	
Finisher	101	
Function icons	18	
Function review	19	
Fusing unit release levers	78	
G		
Group	48, 103	
I		
Initial settings	17	
Interior	13	
Interrupt	44	
J		
Job memory	67	
Job program	67	
K		
Key operator	6	
L		
Loading copy paper	86	
M		
Maintenance		
– maintenance required	72	
– user maintenance	93	
Manual feeding	41	
Manual reduction/enlargement	38	
Margin shift	51	
Misfeed removal		
– bypass tray	75	
– center tray	79	
– finisher	110	
– in the copier	76	
– in the upper exit area	81	
– paper tray	80, 113	
– RSPF	73	

INDEX

N

- Names
- operation panel 14
- part 12
- Non-sort 49, 103

O

- Offset 50
- Operation panel 14
- Options 99
- Original 26

P

- Paper
- loading 86
- special 41
- specifications 41, 86
- Paper size 86
- Paper tray 86
- Part names
- 500-sheet paper feed unit/2x500-sheet paper feed unit 112
- copier 12
- finisher 101
- Photo mode 34
- Platen glass 12
- Power off 16
- Power on 16
- Power save modes 17
- Power switch 16
- Preheat mode 17
- Preset copy ratio 38

R

- Reduction 36
- Replacement
- staple cartridge 107
- toner cartridge 90
- Reversing single pass feeder (RSPF) 26
- Rotation copying 40
- RSPF 26

S

- Sort 48, 103
- Special paper 41
- Specifications
- 500-sheet paper feed unit/2x500-sheet paper feed unit 112
- copier 97
- finisher 102
- paper 41, 86
- Staple cartridge replacement 107
- Staple jam removal 108
- Staple sort 104
- Status messages 72
- Storage of supplies 96
- Stream feeding mode 26
- Supplies 96
- System configuration 100

T

- Text mode 34
- Text/photo mode 34
- Toner cartridge life 92
- Toner cartridge replacement 90
- Total output count 92
- Transparency 65
- Troubleshooting 83
- Two-sided copying 28

U

- User maintenance
- bypass tray paper feed roller 94
- platen glass 93
- RSPF 93

X

- XY zoom 62

Z

- Zoom 36

MATERIAL SAFETY DATA SHEET

Date Issued : Apr. 2. 2001
MSDS NO. F-00981

1. PRODUCT AND COMPANY IDENTIFICATION

Product Name : AR-270NT/270T/270ST/270FT/270NT-J/270ST-C/270FT-T (Black Toner)
Supplier Identification: Sharp Corporation
22-22 Nagaike-cho, Abeno-ku, Osaka, Japan

Local suppliers are listed below. Please contact the nearest supplier for additional information.

(Country)	(Name and Telephone Number)
U.S.A.	Sharp Electronics Corporation Telephone number for information : 1-800-237-4277 Emergency telephone number : 1-800-255-3924
Canada	Sharp Electronics of Canada Ltd. Telephone number for information : 905-890-2100 Emergency telephone number : 1-800-255-3924
United Kingdom	Sharp Electronics (U.K.) Ltd. Telephone number for information : 01923-47-4013
Australia	Sharp Corporation of Australia PTY. Ltd.: Telephone number for information: 1300-13-50-22
Germany	Sharp Electronics (Europe) GMBH Telephone number for information: 40-2376-2737

2. COMPOSITION/INFORMATION ON INGREDIENTS

Substance[]	Preparation[X]					
Ingredient	CAS No.	Proportion	OSHA PEL	ACGIH TLV	MAK-TWA	NOHSC-TWA
Styrene-Acrylate copolymer	29497-14-1	>88.0%	Not listed	Not listed	Not listed	Not listed
Carbon black	1333-86-4	<6.0%	3.5mg/m ³	3.5mg/m ³	Not listed	3mg/m ³
Iron oxide	1309-38-2	<4.5%	Not listed	Not listed	Not listed	Not listed
Metal Complex dye	109125-51-1 109125-50-0 84179-66-8	<1.5%	0.5mg/m ³	0.5mg/m ³	Not listed	Not listed

3. HAZARDS IDENTIFICATION

Most Important Hazards and Effects of the Products

Human Health Effects : There are no anticipated carcinogenic effects from exposure based on animal tests performed using toner. When used as intended according to instructions, studies do not indicate any symptoms of fibrosis will occur.

Environmental Effects : No data are available.

Specific hazards : Dust explosion (like most finely divided organic powders)

4. FIRST-AID MEASURES

Route(s) of Entry:	<u>Inhalation?</u>	<u>Skin?</u>	<u>Ingestion?</u>
	Yes	No	Possible but very unusual.

Inhalation : Remove to fresh air. If symptoms occur, consult medical personnel.

Skin Contact : Wash with soap and water for 15 minutes or until particle is removed.
If irritation does occur, consult medical personnel.

Eye Contact : flush eyes immediately with water for 15 minutes. If irritation does occur, consult medical personnel.

Ingestion : Rinse with water and drink several glasses of water . If irritation or discomfort does occur, consult medical personnel.

5. FIRE -FIGHTING MEASURES

Extinguishing Media : water, CO₂, foam and dry chemicals
Special Fire fighting Procedures : None
Fire and Explosion Hazards : Toner material, like most finely divided organic powders, may form an explosive mixture.

6. ACCIDENTAL RELEASE MEASURES

Personal Precautions : None
Environmental Precautions : None
Methods for Cleaning Up : Wipe off with paper or cloth. DO not use vacuum cleaner when a large amount is released. It, like most finely divided organic powders, is capable of creating a dust explosion.

7. HANDLING AND STORAGE

Handling

Technical Measures : None
Precautions : None
Safe Handling Advice : Use of a dust mask is recommended when handling a large quantity of toner or during long term exposure, as with any non-toxic dust. Try not to disperse the particles.

Storage

Technical Measures : None
Storage Conditions : Keep container closed and Store in a cool and dry place.
Keep out of the reach of children.
Incompatible Products : None

8. EXPOSURE CONTROL/PERSONAL PROTECTION

Engineering Measures

Ventilation : None required with intended use.

Exposure limit values

OSHA-PEL (USA) : 15mg/m³ (Total Dust) , 5mg/m³ (Respirable Dust)
ACGIH-TLV (USA) : 10mg/m³ (Total Dust) , 3mg/m³ (Respirable Dust)

Personal Protective Equipment

Respiratory Protection : None required when used as intended in Sharp equipment.
Hand Protection : None required when used as intended in Sharp equipment.
Eye Protection : None required when used as intended in Sharp equipment.
Skin Protection : None required when used as intended in Sharp equipment.
Other Protective equipment: Use of a dust mask and goggles are recommended when handling a large quantity of toner or during long term exposure, as with any non-toxic dust.

9. PHYSICAL AND CHEMICAL PROPERTIES

Appearance

Physical State: Solid	Form: Powder	Color: Black	Odor: odorless
Ph :	Not applicable		
Boiling/Melting Point :	Not applicable		
Softening Point (°C) :	100-130		
Flash Point (°C) :	Not applicable		
Ignition Point (°C) :	>350		
Explosion Properties :	No data		
Density (g/cm³) :	1.1 (bulk density : 0.35)		
Solubility in water :	Negligible		

10. STABILITY AND REACTIVITY

Stability	: Stable
Hazardous Reactions	: Dust explosion, like most finely divided organic powders.
Conditions to avoid	: Electric discharge, throwing into fire.
Materials to avoid	: Oxidizing Materials
Hazardous Decomposition Products	: CO, CO ₂ and NO _x
Further Information	: None

11. TOXICOLOGICAL INFORMATION

Acute Toxicity

Ingestion(oral)	: LD ₅₀ >2500mg/kg (Rats)
Dermal	: No Data
Inhalation	: No Data
Eye irritation	: Not an irritant (Rabbits)
Skin irritation	: Not an irritant (Rabbits)
Skin sensitizer	: No Data

Mutagenicity : Negative (Ames Test)

Carcinogenicity : In 1996 the IARC reevaluated carbon black as a Group 2B carcinogen (possible human carcinogen). This classification is given to chemicals for which there is inadequate human evidence, but sufficient animal evidence on which to base an opinion of carcinogenicity. The classification is based upon the development of lung tumors in rats receiving chronic inhalation exposures to free carbon black at levels that induce particle overload of the lung. Studies performed in animal models other than rats did not show any association between carbon black and lung tumors. Moreover, a two-year cancer bioassay using a typical toner preparation containing carbon black demonstrated no association between toner exposure and tumor development in rats.

Chronic Effect : In a study in rats of chronic inhalation exposure to a typical toner, a mild to moderate degree of lung fibrosis was observed in 92% of the rats in the high concentration (16mg/m³) exposure group, and a minimal to mild degree of fibrosis was noted in 22% of the animals in the middle (4mg/m³) exposure group, but no pulmonary change was reported in the lowest (1mg/m³) exposure group, the most relevant level to potential human exposures.

12. ECOLOGICAL INFORMATION

No data are available.

13. DISPOSAL CONSIDERATION

Waste from residues	: Waste material may be dumped or incinerated under conditions which meet all federal, state and local environmental regulations.
Contaminated Packaging	: Waste may be disposed or incinerated under conditions which meet all federal, state and local environmental regulations.

14. TRANSPORT INFORMATION

UN Classification	: None
Land DOT (USA)	: None
Sea IMDG	: None
Air ICAO-TI	: None

15. REGULATORY INFORMATION

US Information

TSCA (Toxic Substances Control Act):

All chemical substances in this product comply with all applicable rules or order under TSCA.

SARA (Superfund Amendments and Reauthorization Act) Title III

302 Extreme Hazardous Substance: None

311/312 Hazard Classification : None

EU Information

1999/45/EC and 67/548/EEC

Symbol & Indication : Not required

R-Phrase : Not required

76/769/EEC : All chemical substances in this product comply with all applicable rules or order under 76/769/EEC.

16. OTHER INFORMATION

NFPA Rating (USA) : Health=1 Flammability=1 Reactivity=0

WHMIS Legislation (Canada): This product is not a controlled product.

References

IARC(1996): IARC monographs on the Evaluation of the Carcinogenic Risk of Chemicals to Humans, Vol. 65, Printing Process And Printing Inks, Carbon Black and Some Nitro Compounds, Lyon, pp.149-261

H.Muhle, B.Bellmann, O.Creutzenberg, C.Dasenbrock, H.Ernst, R.Kilpper, J.C.MacKenzie, P.Morrow, U.Mohr, S.Takenaka, and R.Mermelstein(1991) Pulmonary Response to Toner upon Chronic Inhalation Exposure in Rats. Fundamental and Applied Toxicology 17, pp.280-299.

The information on this data sheet represents our current data and best opinion as to the proper use in handling of this product under normal conditions. However, all materials may present unknown hazards and should be used with caution. Although certain hazards are described herein, we do not guarantee that these are the only hazards which exist.

1. PRODUCT AND COMPANY IDENTIFICATION

Product Name : AR-270ND/270DV/270SD/270SD-C (Black Developer)
Supplier Identification: Sharp Corporation
22-22 Nagaike-cho, Abeno-ku, Osaka, Japan

Local suppliers are listed below. Please contact the nearest supplier for additional information.

(Country)	(Name and Telephone Number)
U.S.A.	Sharp Electronics Corporation Telephone number for information : 1-800-237-4277 Emergency telephone number : 1-800-255-3924
Canada	Sharp Electronics of Canada Ltd. Telephone number for information : 905-890-2100 Emergency telephone number : 1-800-255-3924
United Kingdom	Sharp Electronics (U.K.) Ltd. Telephone number for information : 01923-47-4013
Australia	Sharp Corporation of Australia PTY. Ltd.: Telephone number for information: 1300-13-50-22
Germany	Sharp Electronics (Europe) GMBH Telephone number for information: 40-2376-2737

2. COMPOSITION/INFORMATION ON INGREDIENTS

Substance[]	Preparation[X]					
<u>Ingredient</u>	<u>CAS No.</u>	<u>Proportion</u>	<u>OSHA PEL</u>	<u>ACGIH TLV</u>	<u>DFG-MAK</u>	<u>NOHSC-TWA</u>
Iron powder	7439-89-6	>92.5%	Not listed	Not listed	Not listed	Not listed
Styrene-Acrylate copolymer	29497-14-1	<7%	Not listed	Not listed	Not listed	Not listed
Carbon black	1333-86-4	<1%	3.5mg/m ³	3.5mg/m ³	Not listed	3mg/m ³

3. HAZARDS IDENTIFICATION

Most Important Hazards and Effects of the Products

Human Health Effects : There are no anticipated carcinogenic effects from exposure based on animal tests performed using toner. When used as intended according to instructions, studies do not indicate any symptoms of fibrosis will occur.

Environmental Effects : No data are available.

Specific hazards : None

4. FIRST-AID MEASURES

Route(s) of Entry:	<u>Inhalation?</u> No	<u>Skin?</u> No	<u>Ingestion?</u> Possible but very unusual.
---------------------------	--------------------------	--------------------	---

Inhalation : Remove to fresh air. If symptoms occur, consult medical personnel.

Skin Contact : Wash with soap and water for 15 minutes or until particle is removed.
If irritation does occur, consult medical personnel.

Eye Contact : flush eyes immediately with water for 15 minutes. If irritation does occur, consult medical personnel.

Ingestion : Rinse with water and drink several glasses of water . If irritation or discomfort does occur, consult medical personnel.

5. FIRE -FIGHTING MEASURES

Extinguishing Media : water, CO₂, foam and dry chemicals
Special Fire fighting Procedures : None
Fire and Explosion Hazards : Like most finely divided organic powders, it may form an explosive mixture.

6. ACCIDENTAL RELEASE MEASURES

Personal Precautions : None
Environmental Precautions : None
Methods for Cleaning Up : Wipe off with paper or cloth. DO not use vacuum cleaner when a large amount is released. It, like most finely divided organic powders, is capable of creating a dust explosion.

7. HANDLING AND STORAGE

Handling

Technical Measures : None
Precautions : None
Safe Handling Advice : Use of a dust mask is recommended when handling a large quantity of toner or during long term exposure, as with any non-toxic dust. Try not to disperse the particles.

Storage

Technical Measures : None
Storage Conditions : Keep container closed and Store in a cool and dry place.
Keep out of the reach of children.
Incompatible Products : None

8. EXPOSURE CONTROL/PERSONAL PROTECTION

Engineering Measures

Ventilation : None required with intended use.

Exposure limit values

OSHA-PEL (USA) : 15mg/m³ (Total Dust) , 5mg/m³ (Respirable Dust)
ACGIH-TLV (USA) : 10mg/m³ (Total Dust) , 3mg/m³ (Respirable Dust)

Personal Protective Equipment

Respiratory Protection : None required when used as intended in Sharp equipment.
Hand Protection : None required when used as intended in Sharp equipment.
Eye Protection : None required when used as intended in Sharp equipment.
Skin Protection : None required when used as intended in Sharp equipment.
Other Protective equipment: Use of a dust mask and goggles are recommended when handling a large quantity of toner or during long term exposure, as with any non-toxic dust.

9. PHYSICAL AND CHEMICAL PROPERTIES

Appearance

Physical State: Solid Form: Powder Color: Black Odor: odorless

Ph : Not applicable
Boiling/Melting Point : Not applicable
Flash Point (°C) : Not applicable
Explosion Properties : No data
Density (g/cm³) : 7.3 (bulk density : 2.0)
Solubility in water : Negligible

10. STABILITY AND REACTIVITY

Stability	: Stable
Hazardous Reactions	: Dust explosion, like most finely divided organic powders.
Conditions to avoid	: Electric discharge, throwing into fire.
Materials to avoid	: Oxidizing Materials
Hazardous Decomposition Products	: CO, CO ₂ and NO _x
Further Information	: None

11. TOXICOLOGICAL INFORMATION

Acute Toxicity

Ingestion(oral)	: LD ₅₀ >2500mg/kg (Rats)
Dermal	: No Data
Inhalation	: No Data
Eye irritation	: Not an irritant (Rabbits)
Skin irritation	: Not an irritant (Rabbits)
Skin sensitizer	: No Data

Mutagenicity : Negative (Ames Test)

Carcinogenicity : In 1996 the IARC reevaluated carbon black as a Group 2B carcinogen (possible human carcinogen). This classification is given to chemicals for which there is inadequate human evidence, but sufficient animal evidence on which to base an opinion of carcinogenicity. The classification is based upon the development of lung tumors in rats receiving chronic inhalation exposures to free carbon black at levels that induce particle overload of the lung. Studies performed in animal models other than rats did not show any association between carbon black and lung tumors. Moreover, a two-year cancer bioassay using a typical toner preparation containing carbon black demonstrated no association between toner exposure and tumor development in rats.

Chronic Effect : In a study in rats of chronic inhalation exposure to a typical toner, a mild to moderate degree of lung fibrosis was observed in 92% of the rats in the high concentration (16mg/m³) exposure group, and a minimal to mild degree of fibrosis was noted in 22% of the animals in the middle (4mg/m³) exposure group, but no pulmonary change was reported in the lowest (1mg/m³) exposure group, the most relevant level to potential human exposures.

12. ECOLOGICAL INFORMATION

No data are available.

13. DISPOSAL CONSIDERATION

Waste from residues	: Waste material may be dumped or incinerated under conditions which meet all federal, state and local environmental regulations.
Contaminated Packaging	: Waste may be disposed or incinerated under conditions which meet all federal, state and local environmental regulations.

14. TRANSPORT INFORMATION

UN Classification	: None
Land DOT (USA)	: None
Sea IMDG	: None
Air ICAO-TI	: None

15. REGULATORY INFORMATION

US Information

TSCA (Toxic Substances Control Act):

All chemical substances in this product comply with all applicable rules or order under TSCA.

SARA (Superfund Amendments and Reauthorization Act) Title III

302 Extreme Hazardous Substance : None

311/312 Hazard Classification : None

EU Information

1999/45/EC and 67/548/EEC

Symbol & Indication : Not required

R-Phrase : Not required

76/769/EEC : All chemical substances in this product comply with all applicable rules or order under 76/769/EEC.

16. OTHER INFORMATION

NFPA Rating (USA) : Health=1 Flammability=1 Reactivity=0

WHMIS Legislation (Canada): This product is not a controlled product.

References

IARC(1996) : IARC monographs on the Evaluation of the Carcinogenic Risk of Chemicals to Humans, Vol. 65, Printing Process And Printing Inks, Carbon Black and Some Nitro Compounds, Lyon, pp.149-261

H.Muhle, B.Bellmann, O.Creutzenberg, C.Dasenbrock, H.Ernst, R.Kilpper, J.C.MacKenzie, P.Morrow, U.Mohr, S.Takenaka, and R.Mermelstein(1991) Pulmonary Response to Toner upon Chronic Inhalation Exposure in Rats. Fundamental and Applied Toxicology 17, pp.280-299.

The information on this data sheet represents our current data and best opinion as to the proper use in handling of this product under normal conditions. However, all materials may present unknown hazards and should be used with caution. Although certain hazards are described herein, we do not guarantee that these are the only hazards which exist.

WARNING:

FCC Regulations state that any unauthorized changes or modifications to this equipment not expressly approved by the manufacturer could void the user's authority to operate this equipment.

Note:

This equipment has been tested and found to comply with the limits for a Class A digital device, pursuant to part 15 of the FCC Rules. These limits are designed to provide reasonable protection against harmful interference when the equipment is operated in a commercial environment. This equipment generates, uses, and can radiate radio frequency energy and, if not installed and used in accordance with the operation manual, may cause harmful interference to radio communications. Operation of this equipment in a residential area is likely to cause harmful interference in which case the user will be required to correct the interference at his own expense.

NOTICE

BE SURE TO ASK YOUR AUTHORIZED SHARP DEALER ABOUT THE WARRANTY THAT YOUR SELLING DEALER EXTENDS TO YOU. In order to assure you, the end-user, of warranty protection, Sharp extends a limited warranty to each of its authorized dealers and, in turn, requires each of its authorized dealers to extend its own warranty to you on terms that are no less favorable than those given to the dealer by Sharp. You should be aware, however, that Sharp does not itself extend any warranties, either express or implied, directly to you, the end-user, and no one is authorized to make any representations or warranties on behalf of Sharp. Specifically, SHARP DOES NOT EXTEND TO YOU, THE END-USER, ANY EXPRESS WARRANTY OR ANY IMPLIED WARRANTY OF MERCHANTABILITY, FITNESS FOR USE OR FITNESS FOR ANY PARTICULAR PURPOSE IN CONNECTION WITH THE HARDWARE, SOFTWARE OR FIRMWARE EMBODIED IN, OR USED IN CONJUNCTION WITH THIS PRODUCT. Sharp is not responsible for any damages or loss, either direct, incidental or consequential, which you, the end-user, may experience as a result of your purchase or use of the hardware, software or firmware embodied in or used in conjunction with this Product. Your sole remedy, in the event that you encounter any difficulties with this Product, is against the authorized dealer from which you purchased the Product.

AR-M208 Digital Multifunctional system

In the event that this authorized dealer does not honor its warranty commitments, please contact the General Manager, Business Products Group, Sharp Electronics Corporation, Sharp Plaza, Mahwah, NJ 07430-2135, so that Sharp can try to help assure complete satisfaction of all the warranty rights to which you are entitled from the authorized dealer.

SHARP[®]

SHARP ELECTRONICS CORPORATION

Sharp Plaza, Mahwah, New Jersey 07430-2135.

www.sharp-usa.com

SHARP CORPORATION